



SSP

Safety System Products

S14LDRB-H09-E2-I1-I1-Q1A0-Q2A0-Q3C0-Q4S0-W43

Safety Simplifier | for Atom

Your advantages

- 14 I/O's as safety Inputs or redundant OSSD-Outputs
- wireless Interface for safe communication, programming & diagnosis
- IP65
- 40mm width for aluminium safety fence systems



To the downloads ►

we simplify safety



Safety System Products

S14LDRB-H09-E2-I1-I1-Q1A0-Q2A0-Q3C0-Q4S0-W43

- S14LDRB-H09: Safety Simplifier with 14 I/Os
LED Diagnosis for simple handling
safe wireless communication
Box Bottom: anthracite, 2 holes backside for cable access
Top of box: yellow; possibility to mount three buttons
- E2: E-Stop (twist reset), Safety s 2 x NC, illuminated
- I1: Illuminated pushbutton (5 colours), Safety 1 x NO
- I1: Illuminated pushbutton (5 colours), Safety 1 x NO
- Q1A0: connection bottom left side including plug
- Q2A0: connection top left side including plug
- Q3C0: connection bottom right side including male plug M12-5 Pin
- Q4S0: connection top right side including socket plug M12-8 Pin for ATOM
- W34: pre wired

General data

Type designation	S14LDRB-H09-E2-I1-I1-Q1A0-Q2A0-Q3C0-Q4S0-W43
Item number	SP-X-89-100-12
Functional type	safety PLC with safe wireless interface, internal antenna

Button position 1

Type designation	E2
Function type	Illuminated Emergency-Stop-Button , 2 x NC

Button position 2

Type designation	I1
Function type	Illuminated button , 1x NO (5 x button caps included)

Button position 3

Type designation	I1
Function type	Illuminated button , 1x NO (5 x button caps included)
Colour	red, yellow, green, blue, white

Connection

- Position 1	Q1A0 - Connection bottom left with cover
--------------	--



Safety System Products

S14LDRB-H09-E2-I1-I1-Q1A0-Q2A0-Q3C0-Q4S0-W43

- Position 2	Q2A0 - Connection top left with cover
- Position 3	Q3C0- connection bottom right side including male plug M12-5 Pin
- Position 4	Q4S0 - connection top right side including socket plug M12-8 Pin for ATOM

Safety data

- EN ISO 13849-1: 2008	Category 4
- IEC 61508-2	SIL CL 3
- EN 62061 PFHD [1/h]	□

1-channel input

- EN ISO 13849-1: 2008	Category 2
- IEC 61508-2	SIL CL 2
- EN 62061 PFHD [1/h]	□
- EN ISO 13849-1: 2008 TM [Year]	20

2-channel input

- EN ISO 13849-1: 2008	Category 4
- IEC 61508-2	SIL CL 3
- EN 62061 PFHD [1/h]	□
- EN ISO 13849-1: 2008 TM [Year]	20

1-channel OSSD output

- EN ISO 13849-1: 2008	Category 2
- IEC 61508-2	SIL CL 2
- EN 62061 PFHD [1/h]	□
- EN ISO 13849-1: 2008 TM [Year]	20

2- channel OSSD Output

- EN ISO 13849-1: 2008	Category 4
- IEC 61508-2	SIL CL 3
- EN 62061 PFHD [1/h]	□
- EN ISO 13849-1: 2008 TM [Year]	20

2- channel relais output

- EN ISO 13849-1: 2008	Category 4
- EN 62061 SIL CIL	SIL CL 3



Safety System Products

S14LDRB-H09-E2-I1-I1-Q1A0-Q2A0-Q3C0-Q4S0-W43

- EN 62061 PFHD [1/h]	□
- EN ISO 13849-1: 2008 TM [Year]	20

Environmental conditions

Max. storage temperature	-20°C ... +65 °C
Max. operating temperature	-20°C ... +65 °C

Electrical data

Technical data wireless safety

- max. amount of safe wireless channels	16
- Channel 1	2405 MHz
- Channel 2	2410 MHz
- Channel 3	2415 MHz
- Channel 4	2420 MHz
- Channel 5	2425 MHz
- Channel 6	2430 MHz
- Channel 7	2435 MHz
- Channel 8	2440 MHz
- Channel 9	2445 MHz
- Channel 11	2455 MHz
- Channel 10	2450 MHz
- Channel 12	2460 MHz
- Channel 13	2465 MHz
- Channel 14	2470 MHz
- Channel 15	2475 MHz
- Channel 16	2480 MHz
- amount of clamps	32
Supply voltage	10 - 30 V
Current consumption	110 mA with LED display

Conductor cross section

- single wire	0,08 ... 0,5 mm ²
- fine wire	0,08 ... 0,5 mm ²
- fine wired (wire sleeve without plastic collar)	0,25 mm ²



Safety System Products

S14LDRB-H09-E2-I1-I1-Q1A0-Q2A0-Q3C0-Q4S0-W43

stripping length 5-6 mm

configurable In-/ Outputs

14 semiconductor In-/ Outputs with help of software configurable

Amount of safe inputs	max. 14
Amount of safe semi-conductors OSSD outputs	max. 14
Amount of semi-conductors auxilliary outputs	max. 14
Amount of semi-conductors clock outputs	max. 8
Input current	HIGH 2,4 mA ... 3,8 mA LOW -2,5 mA ... 2,1 mA
Output type	PNP semiconductor
Output voltage	Operating Voltage UB -0,5 V
Seperate output current	max. 600 mA (with UB 24 V)
Total output current	max. 2 A (with UB 24 V)

Button position 1

Type designation	E2
Function type	Emergency-stop-button
Switch type	2 Openers + LED
Bounce time NO	<10 ms
Bounce time NC	<10 ms
Break contact force opening	according to EN60947-5-1 Anh-K.
Illumination	LED
mechanical lifespan	50.000 switching cycles
electrical lifespan	50.000 switching cycles

Button position 2

Type designation	I1
Function type	Illuminated Button
Switch type	1 closing device + LED
Bounce time NO	< 10
Bounce time NC	< 10
Break contact force opening	according to EN60947-5-1 Anh-K.
Illumination	LED
mechanical lifespan	30.000 switching cycles
electrical lifespan	30.000 switching cycles

Button position 3



S14LDRB-H09-E2-I1-I1-Q1A0-Q2A0-Q3C0-Q4S0-W43

Type designation	I1
Function type	Illuminated Button
Colour	red, yellow, green, blue, white
Switch type	1 closing device + LED
Break contact force opening	according to EN60947-5-1 Anh-K.
Illumination	LED
mechanical lifespan	30.000 switching cycles
electrical lifespan	30.000 switching cycles
General data	
Memory card	Installation of memory card MEM SP-N-88-001-93 possible
Programming connection	Micro USB Wireless Interface
Type terminal connection	clamp terminal
- fine wired (wire sleeve with plastic collar)	0,08 ... 0,5 mm ²
Input voltage	HIGH 75% from UB (adjustable by software) LOW 25% from UB (adjustable by software)
Technical data inputs	
Technical data safe OSSD outputs, auxilliary and test pulse outputs	
Short-circuit proof	YES
Mechanical data	
Installation opening of buttons	22,5 mm
Type of housing	H10
Dimensions	
Height	44 mm
Length	253 mm
Width	42 mm

S14LDRB-H09-E2-I1-I1-Q1A0-Q2A0-Q3C0-Q4S0-W43

Electrical drawings

Connection example 1

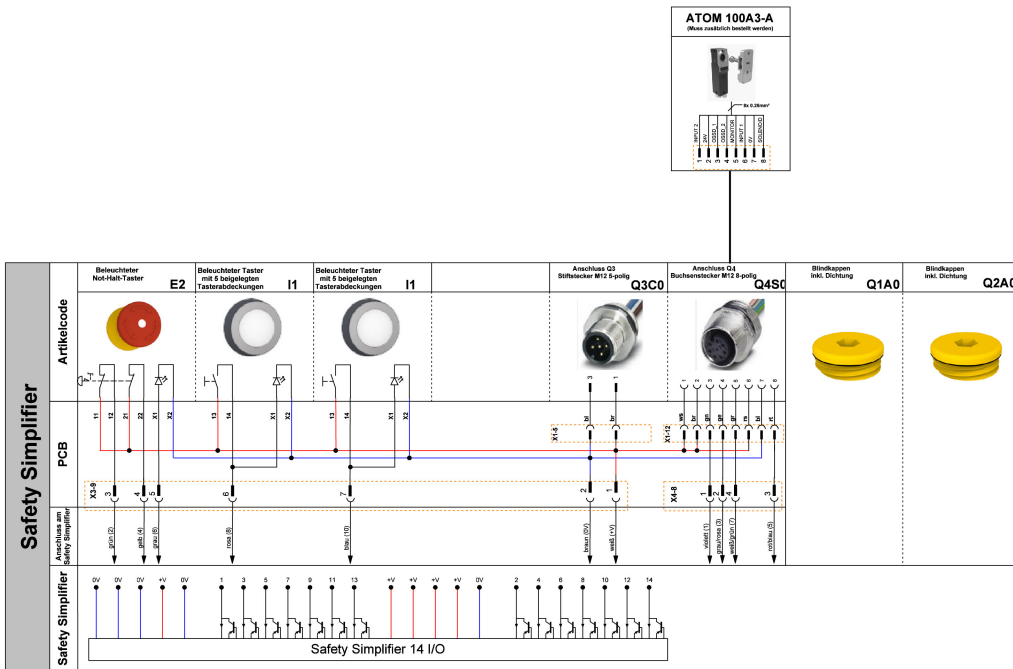

S14LDRB-H09-E2-I1-I1-Q1A0-Q2A0-Q3C0-Q4S0-W43

Drawings

Assembly

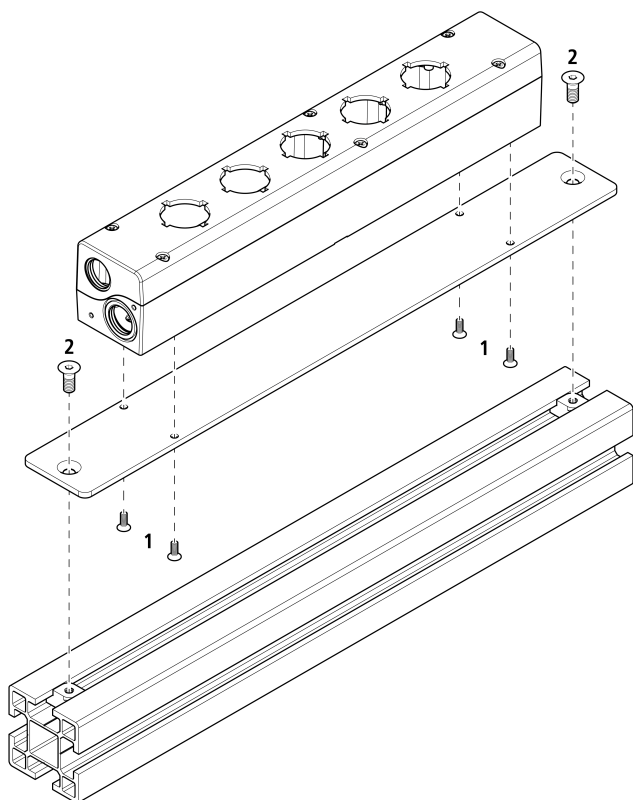

- 1.) Gehäuse über den dafür vorgesehenen Bohrungen positionieren und mit den vier mitgelieferten M3 Senkkopfschrauben auf der Montageplatte befestigen.
- 2.) Montageplatte mit zwei M5 Senkkopfschrauben (nicht im Lieferumfang enthalten) zum Beispiel auf einer Profilschiene befestigen.

S14LDRB-H09-E2-I1-I1-Q1A0-Q2A0-Q3C0-Q4S0-W43

Assembly 2

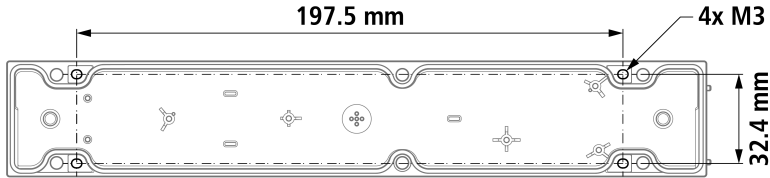

Befestigungsvariante 1:

Von aussen, mit vier M3 Schrauben an den dafür vorgesehenen Langlöchern.

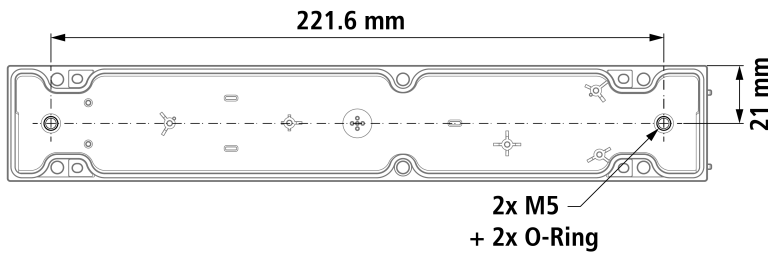

Befestigungsvariante 2:

Im Gehäuseinnern, mit zwei mit O-Ringen bestückten M5 Schrauben an beiden Enden des Gehäuses. Die Öffnungen für die beiden M5 Schrauben müssen dabei herausgebrochen werden.

S14LDRB-H09-E2-I1-I1-Q1A0-Q2A0-Q3C0-Q4S0-W43



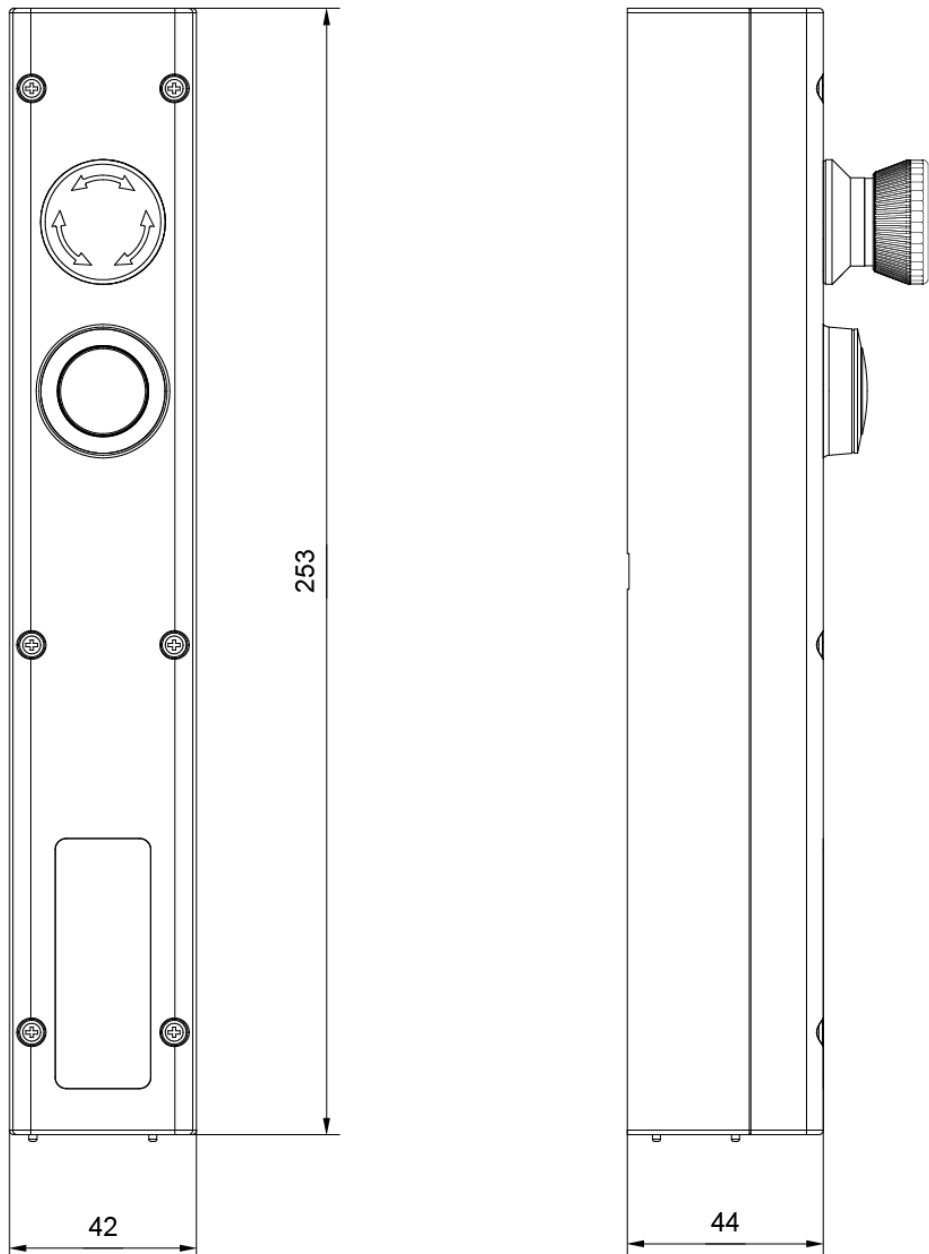

Dimensions





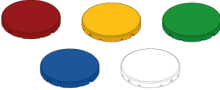

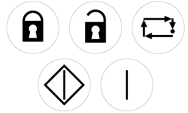
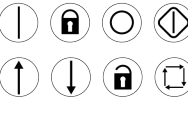



Equipment

Wireless Safety

S14LDRB-H09-E2-I1-I1-Q1A0-Q2A0-Q3C0-Q4S0-W43

Article code ZTK5	Button cap set for illuminated buttons	SP-X-88-001-19	
	Inscription label set ZB1	SP-X-88-001-21	
	Inscription label set ZB2	SP-X-88-001-22	
	Inscription label set ZB3	SP-X-88-001-23	
	Inscription label set ZB4	SP-X-88-001-93	
Article code ZMT	Installation wrench	SP-X-88-001-25	
Article code ZUK	Liftingtool for button and light caps	SP-X-88-001-26	

S14LDRB-H09-E2-I1-I1-Q1A0-Q2A0-Q3C0-Q4S0-W43

Article code ZMB	Mounting plate big	SP-N-88-850-02	
Article code ZMS	Mountingplate small	SP-N-88-850-01	
Article code ZSD	Screw with seal	SP-X-88-001-89	
External antenna for Safety Simplifier, cable length 1 m	Simplifier EXTA 1 m	SP-X-88-200-24	
External antenna for Safety Simplifier, cable length 10 m	Simplifier EXTA 10 m	SP-X-88-200-20	
External antenna for Safety Simplifier, cable length 2 m	Simplifier EXTA 2 m	SP-X-88-200-23	
External antenna for Safety Simplifier, cable length 5 m	Simplifier EXTA 5 m	SP-X-88-200-22	
External antenna for Safety Simplifier, cable length 8 m	Simplifier EXTA 8 m	SP-X-88-200-21	

S14LDRB-H09-E2-I1-I1-Q1A0-Q2A0-Q3C0-Q4S0-W43

Free software for the Safety Simplifier System

Simplifier Manager



Simplifier Monitor SRM

SP-N-88-850-03



Fastening set for Safety Simplifier for back panel

Simplifier ZHMS

SP-X-88-001-91



mounting

Fastening set for Safety Simplifier

Simplifier ZHS

SP-X-88-001-91



Downloads

- Catalog
- Certificates
- Product line
- Catalog packaging systems
- Operating manual
- EPLAN-Data