



# SAFETY SIMPLIFIER

Solutions for injection molding machines

# Use of EUROMAP interfaces on injection molding machines

Injection molding machines have high safety requirements. PLe performance level and door monitoring with protection against manipulation are basic requirements for the safety concept. Injection molding machine manufacturers often use standardized interfaces to integrate their safety equipment.

EUROMAP 73 was originally regulated by DIN EN ISO 201:2009. This requires three safety switches per safety gate, which ensure tamper resistance with the help of the plausibility check. The newer EUROMAP 78, on the other hand, requires intrinsically safe OSSD signals (Output Switching Signal Device) and a highly coded safety switch according to DIN EN ISO 14119.

The integration of EUROMAP interfaces makes it easier for integrators and operators to implement safety-related requirements for applications that are not very complex. However, for many safety applications users quickly reach their limits with the existing interfaces and require additional safety controllers. This leads to more wiring and higher costs.

SSP offers the Safety Simplifier, a simplified **plug & play safety solution** with integrated EUROMAP 67, 73 or 78 interface. The Safety Simplifier significantly facilitates the integration and expansion of the safety concept. These communicate safely via wireless or CAN communication (PLe) and only safety switches require connection. This can significantly reduce the planning and wiring effort.

## Example of an injection molding plant with a gantry robot

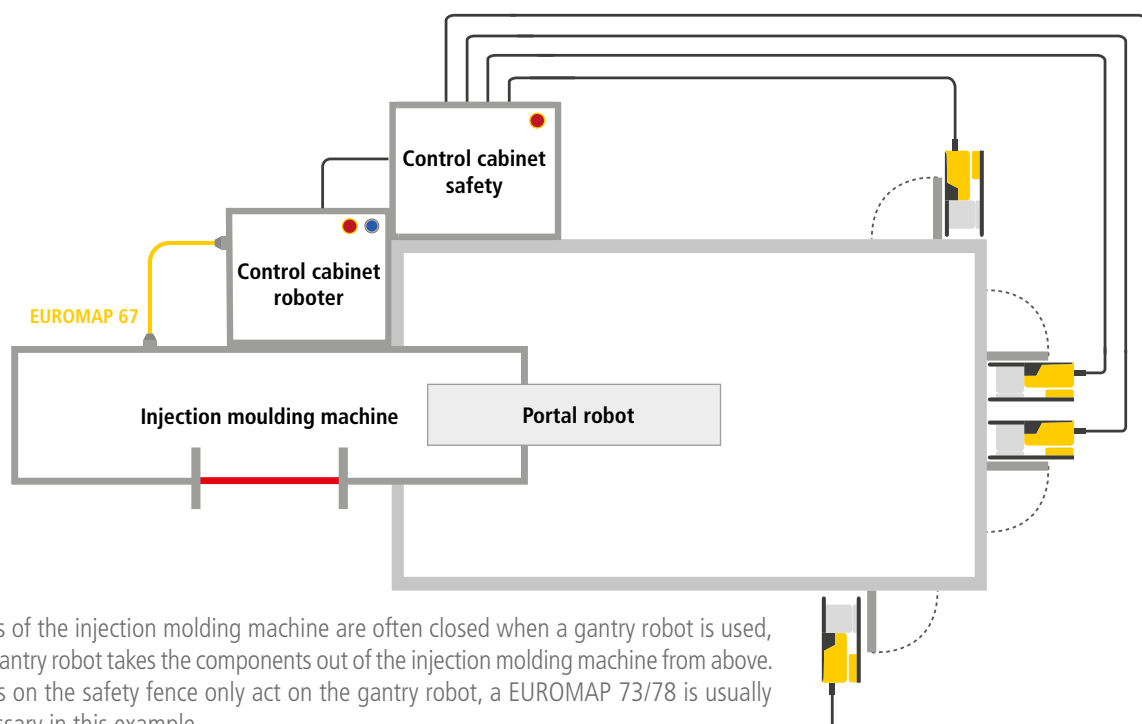

The doors of the injection molding machine are often closed when a gantry robot is used, and the gantry robot takes the components out of the injection molding machine from above. The doors on the safety fence only act on the gantry robot, a EUROMAP 73/78 is usually not necessary in this example.

# EUROMAP

## EUROMAP 78

Interface for integration of an external safety device (modern safety switch with highly coded actuator and OSSD signal)

## EUROMAP 73

Interface for integration of a safety device with 3 safety switches per door

## EUROMAP 67

Interface for the integration of e.g. industrial and gantry robots, units and additional machine modules

### Example of an injection molding plant with an industrial robot

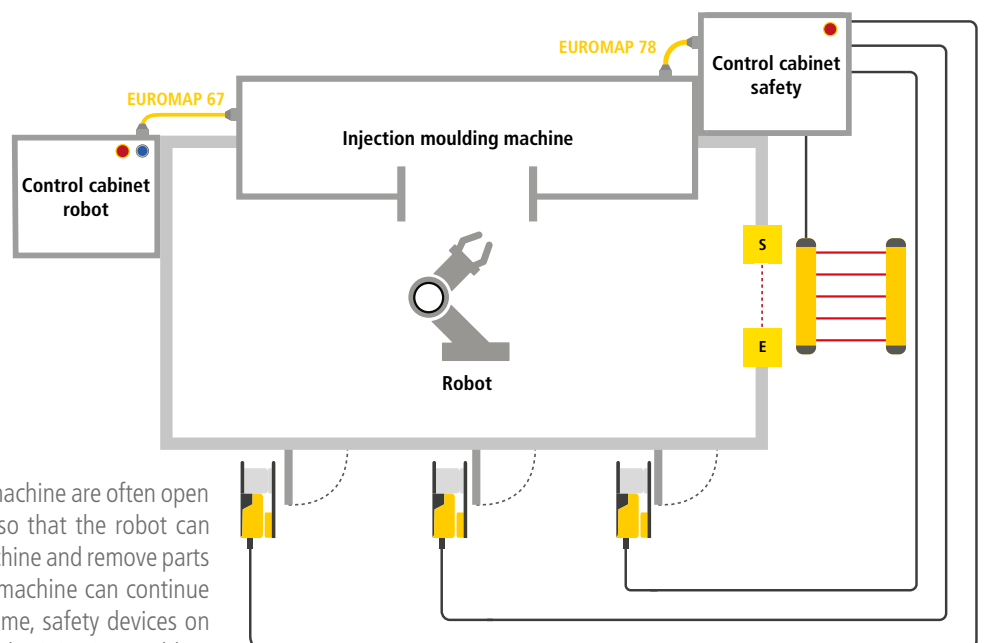

The doors of the injection molding machine are often open when an industrial robot is used, so that the robot can reach into the injection molding machine and remove parts from the mold. To ensure that the machine can continue to be operated safely during this time, safety devices on the safety fence are connected to the injection molding machine via the EUROMAP 78 interface.

# Safety Simplifier

## Central & Decentralized Safety Controller

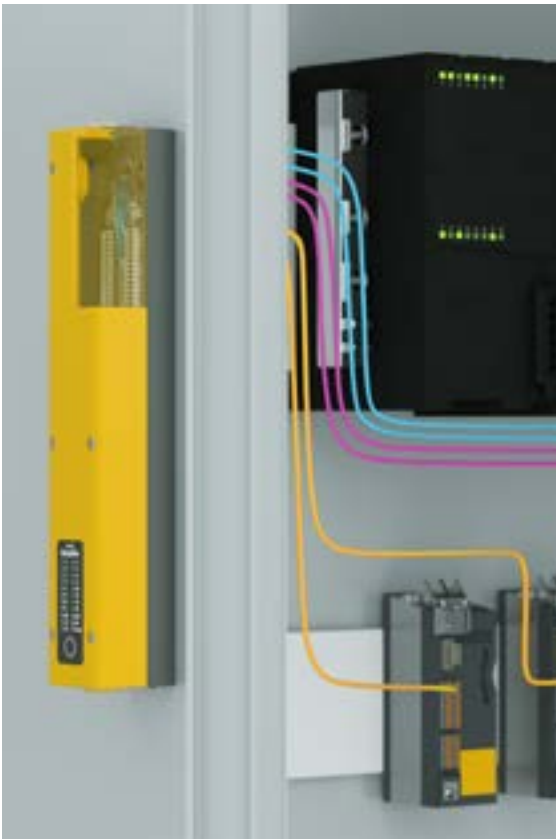

The Safety Simplifier is a flexible safety controller that can be used either centrally or decentrally. Thanks to wireless communication, the wiring effort is significantly reduced.

This means that fewer cables are required and resources such as time and materials can be saved during planning, documentation, setup and commissioning. A control cabinet for the safety technology becomes unnecessary.

The flexibly configurable inputs and outputs of each Safety Simplifier facilitate the creation of safety systems.

Due to the multi-master principle each communicating Safety Simplifier is also a repeater. This principle creates a secure mesh network in which each Safety Simplifier shares its global information with all participants within its range.

Spring-loaded terminals  
secure the connections also  
in case of strong vibrations

4 relays for  
2 x double-safety  
outputs (optional)

Memory card with  
application software for  
easy exchange

USB-C interface for  
programming and  
diagnosis



Feed-through to the  
control cabinet

14 I/O that can be used as safety  
inputs or redundant OSSD outputs

Safe wireless  
Interface (optional)

Safe CAN interface  
(optional)

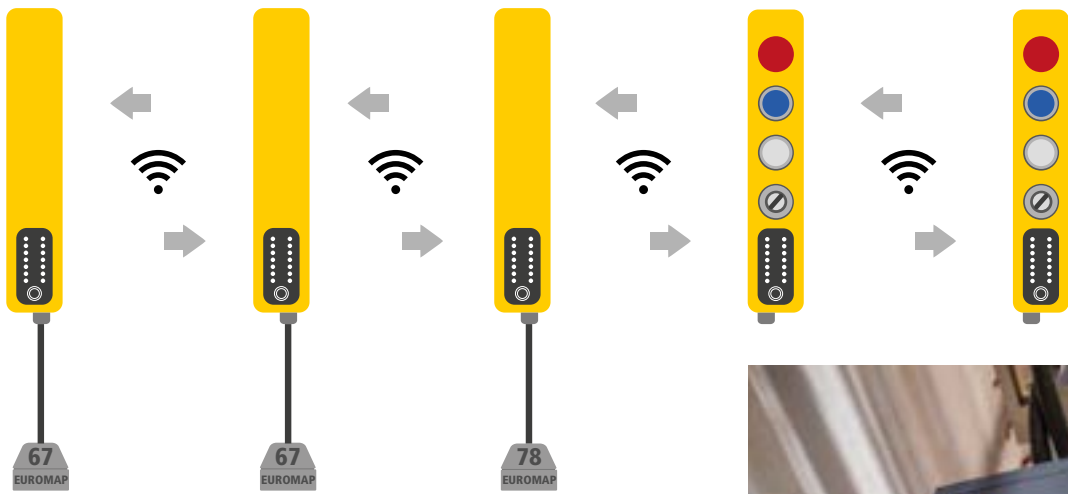

- ✓ Flexible and safe solution for decentralized applications
- ✓ High safety up to SIL3 - PLe - Category 4
- ✓ 16 safe inputs and outputs, flexible and customizable
- ✓ Predefined functional modules for easy and fast programming



# EUROMAP 78

---

The EUROMAP 78 defines the connection between an injection molding machine and an external safety device. It requires a two-channel safe signal (OSSD) according to the specified performance level, which can be provided by a safety switch and/or a safety controller.

The safety signals at pins a7 and b7 of the EUROMAP 78 may only switch on when the safety device is closed, locked and confirmed.

Only one safety switch/emergency stop button can be connected directly to a EUROMAP 78 interface at a time. If more safety doors are required, an additional interface must be requested from the manufacturer of the injection molding machine or an additional safety controller in an external control cabinet takes over the connection of several safety doors to one EUROMAP 78 interface.

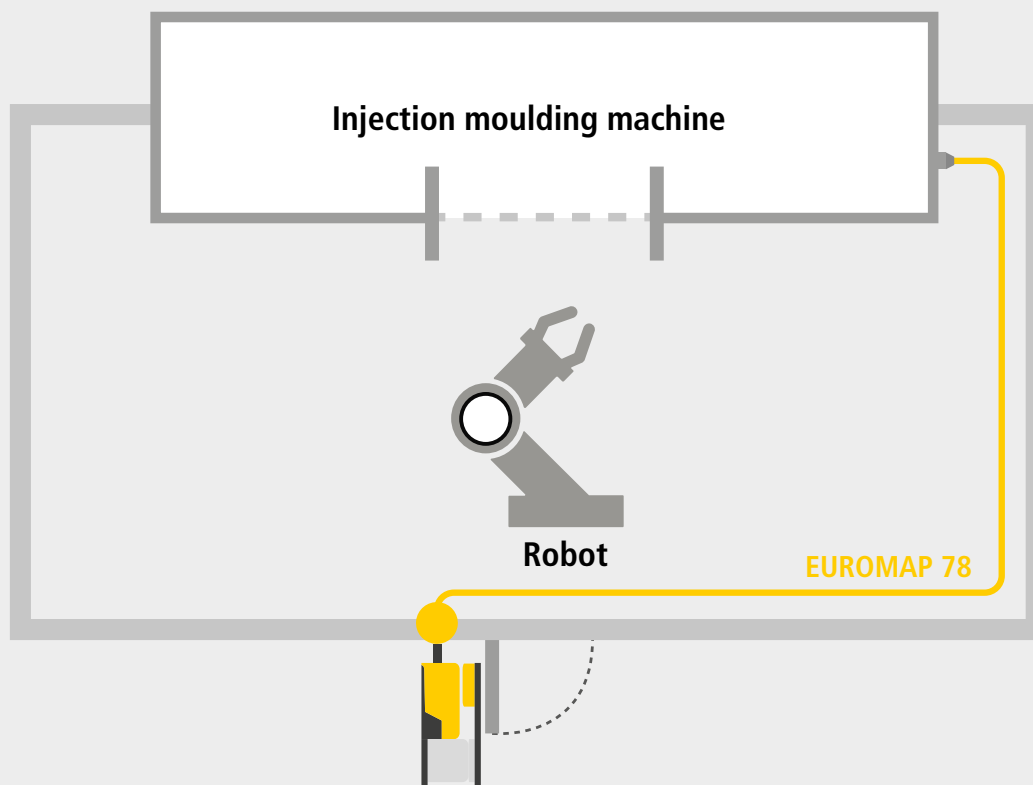

## EUROMAP 78 interface

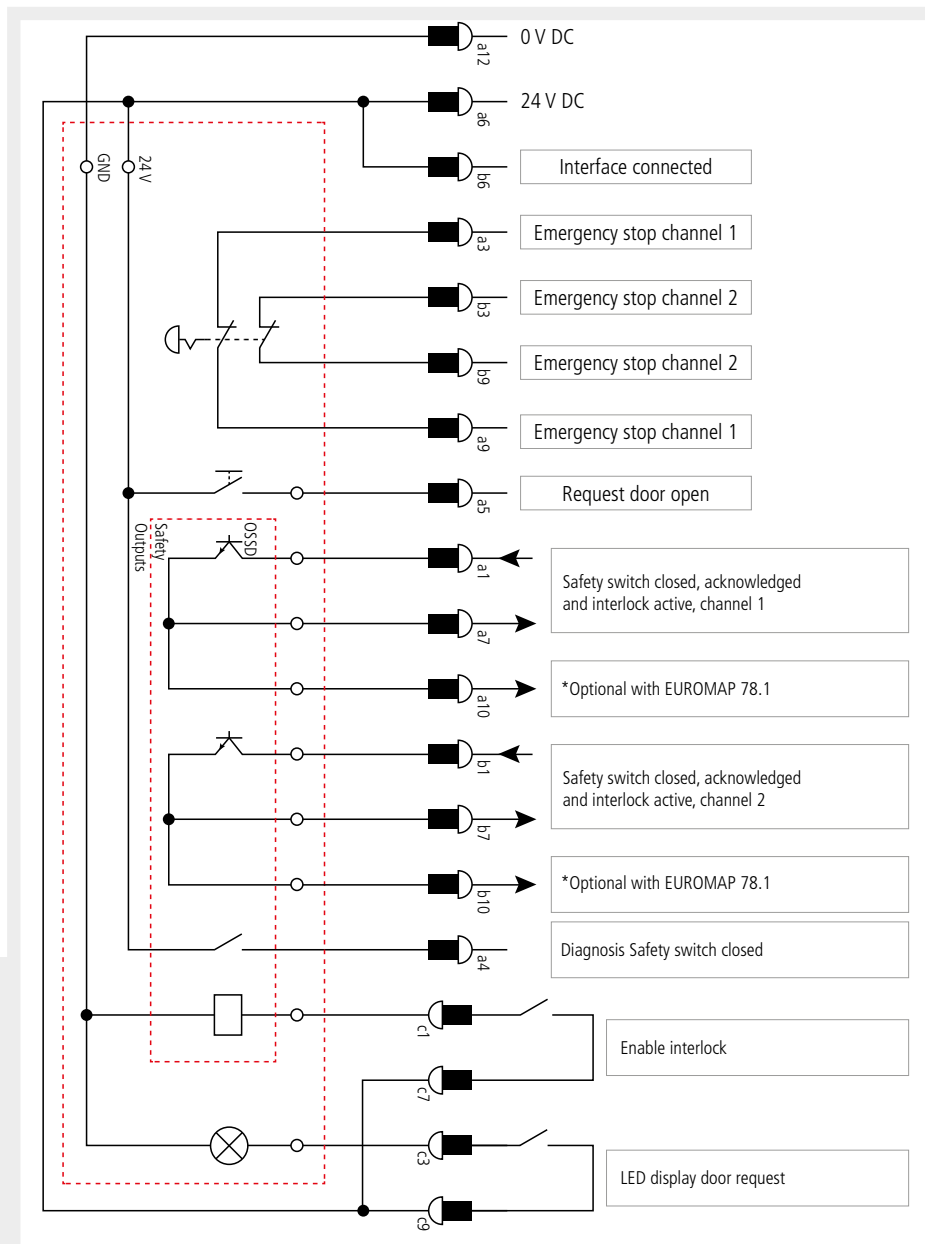

### Difficulties encountered by users with a EUROMAP 78 interface:

- ? How can a safety switch be connected to the EUROMAP 78 interface so that the safety signals a7 and b7 are confirmed without connection of an additional safety evaluation in an external safety cabinet?
- ? How can several safety gates be connected to one EUROMAP 78 interface at the same time?
- ? How can the emergency stop button on a door switch off other peripheral modules/systems in the application if the connection only leads to the injection molding machine?
- ? How can a back-step protection or pre-reset according to DIN EN ISO 20430:2020 be integrated into the EUROMAP 78 interface?

# EUROMAP 78

with  
**SAFETY  
SIMPLIFIER**



Safety switches, guard locks or RFID sensors can be easily connected to a Safety Simplifier via an M12 plug. This is mounted directly on the safety gate.

Thanks to secure wireless or CAN communication, up to 15 safety gates can be connected to one EUROMAP 78 interface with the Safety Simplifier. The EUROMAP Safety Simplifier is connected directly to the injection molding machine via a fixed cable with Harting plug.

Safety functions such as emergency stop, door request or reset are implemented directly in the Safety Simplifier and can be configured in the Simplifier Manager software without any programming knowledge. Thanks to ready-to-use functional modules and prescribed programs, the programming of the safety controller is quick and easy.

The safe OSSD outputs are only enabled after all doors have been closed, held shut and acknowledged.

## Connection Safety Simplifier EUROMAP 78

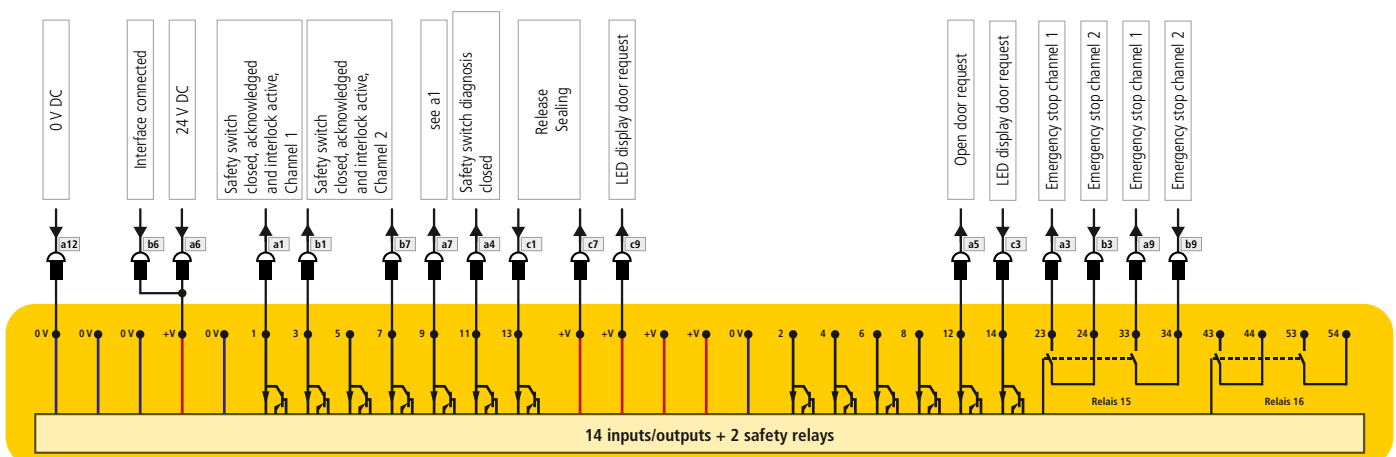

Item no.: SP-X-89-100-31  
S16LDRB-H06-Q1A0-Q2A1-Q3A0-Q4A0-W55



# Example of the Safety Simplifier EUROMAP 78 Implementation

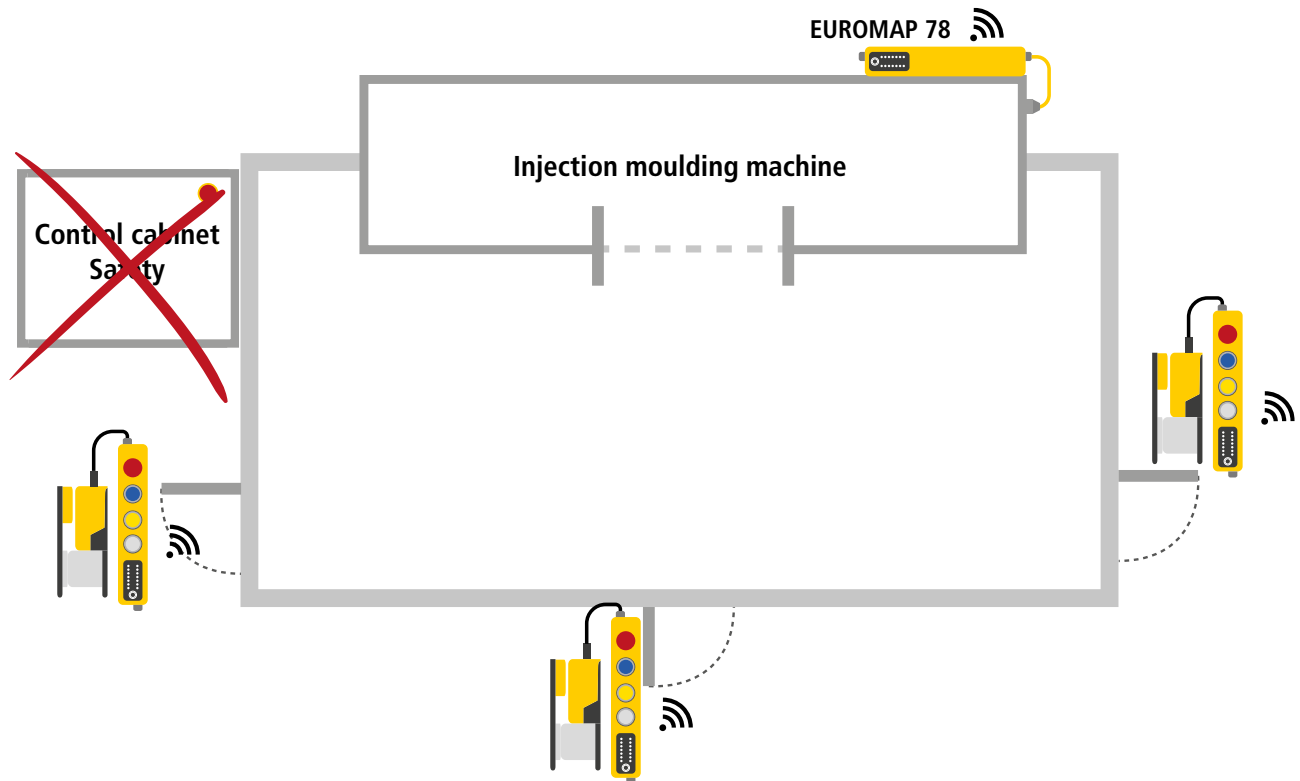

Up to 15 safety door systems can communicate with one injection molding machine via secure wireless or CAN communication.

## Advantages

- ✓ Safety outputs pin a7 and b7 are only switched on after confirmation of the safety switches
- ✓ Connection of up to 15 doors to one EUROMAP interface
- ✓ Wireless communication for fast, wiring-reduced commissioning
- ✓ No need to use additional safety controllers
- ✓ Emergency stop functions can switch off further peripheral systems via the wireless interface
- ✓ Unproblematic plant expansion using additional safety doors is possible in a short period of time

# EUROMAP 78.1

with

**SAFETY  
SIMPLIFIER**

In DIN EN ISO 20430:2020, a double reset or acknowledgement process "Pre-Reset" is described in Annex F2. This function is always necessary when full body access to the mold area of the injection molding machine is possible and other protective measures for detecting persons, such as laser scanners or safe radar sensors, cannot be implemented.

In the case of a pre-reset function, several reset buttons can be used to control all non-visible areas during the reset process. The risk assessment is used to determine a reasonable sequence by which persons in the danger zone must be detected and identified.

The pre-reset procedure for the detection of persons is additionally described in the robot standard DIN EN ISO 10218-2:2012-06, Chapter 5.6.3.4.3.

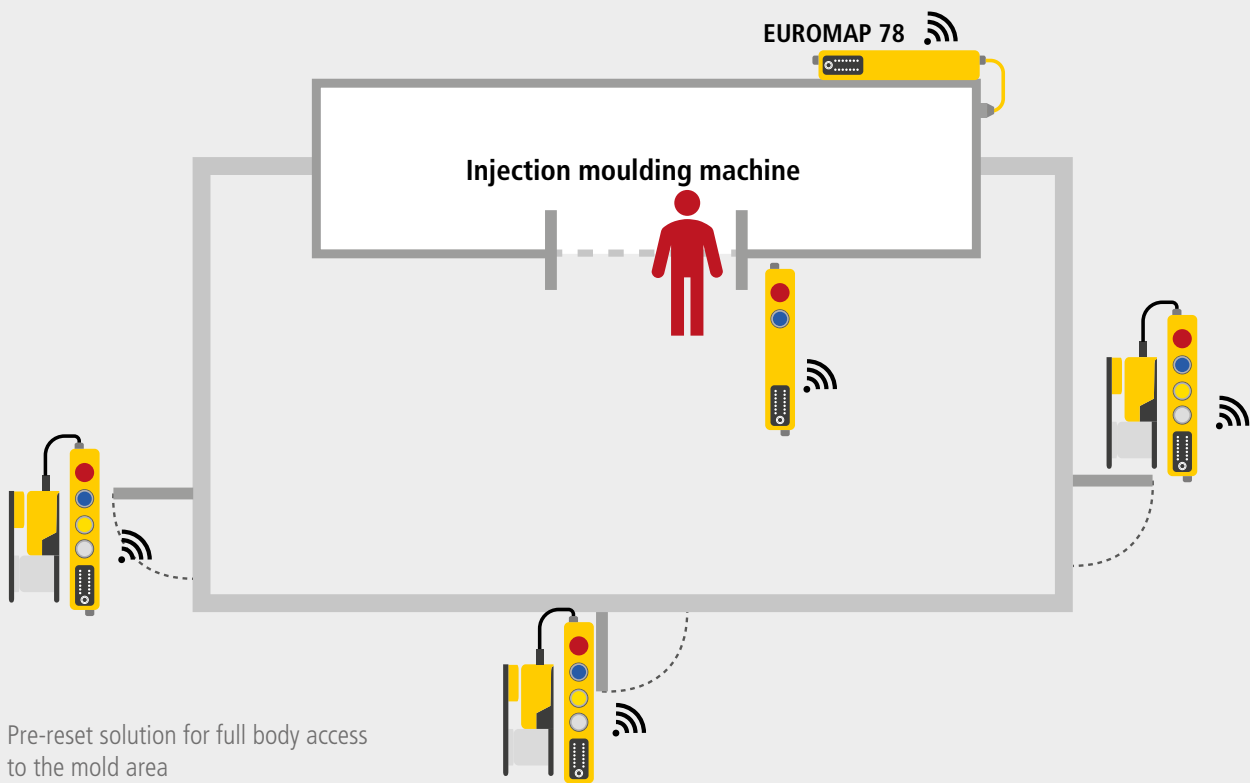

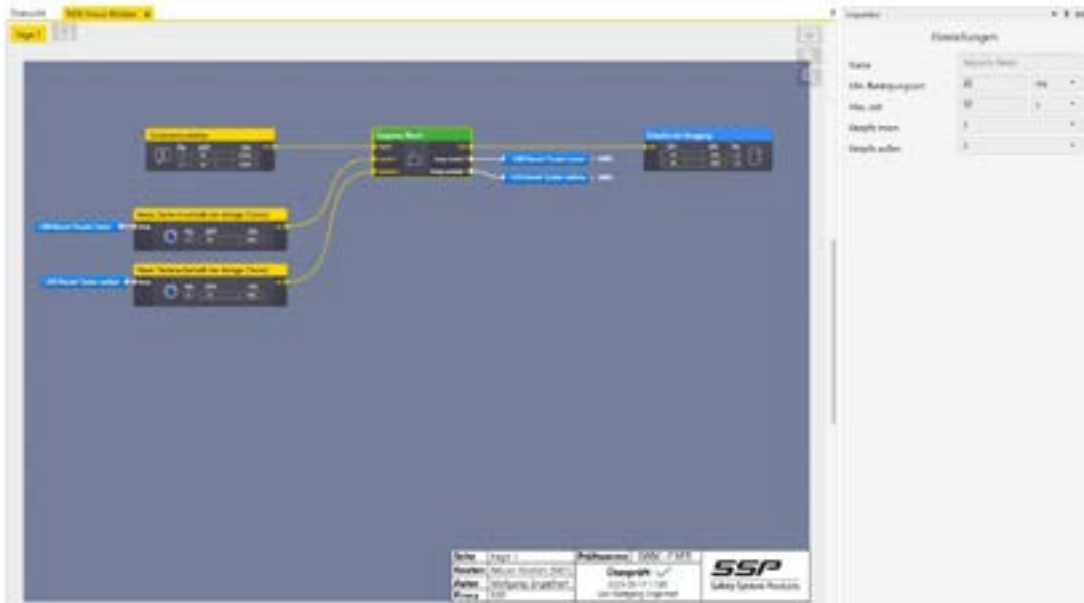

Implementation of the pre-reset function with the Safety Simplifier using the free software Simplifier Manager

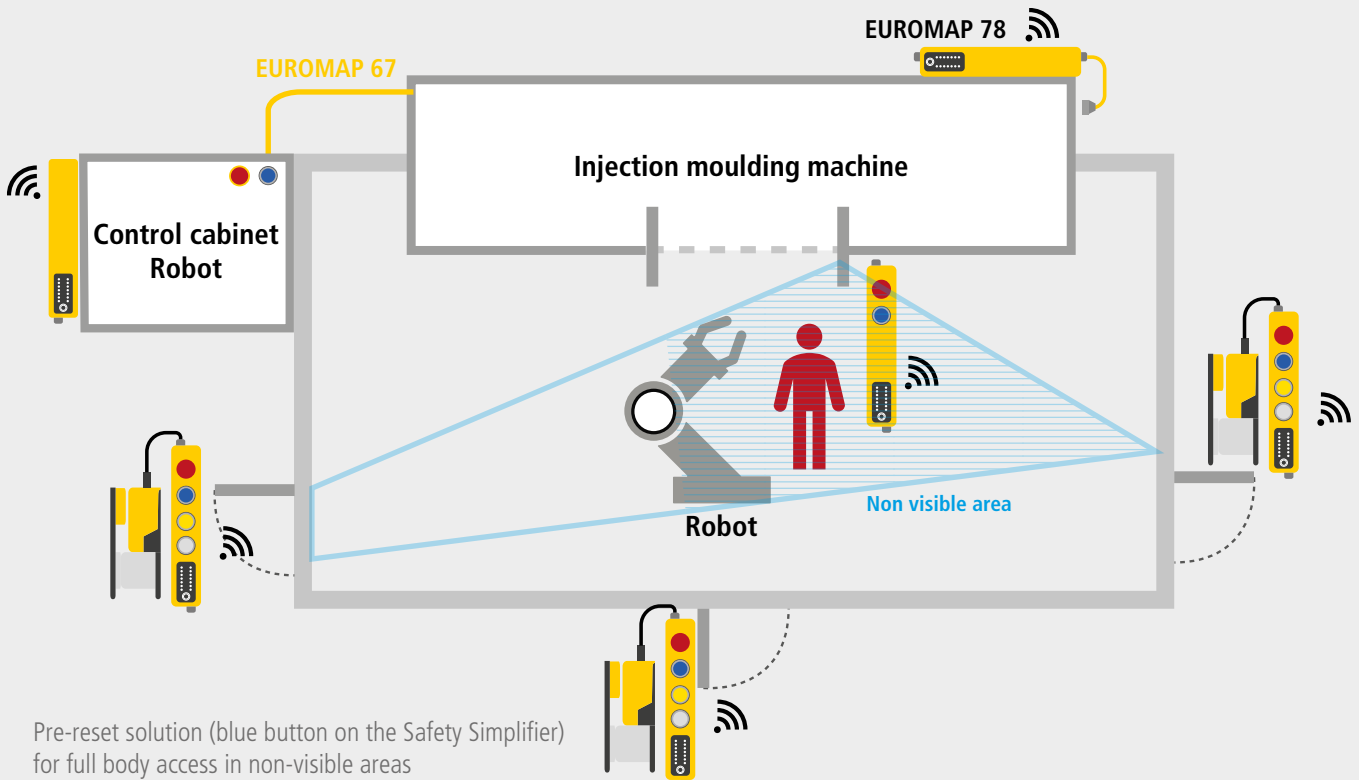

Pre-reset solution (blue button on the Safety Simplifier) for full body access in non-visible areas

# EUROMAP 73

EUROMAP 73 requires three safety switches per safety door. A plausibility check during opening and closing of the door is used to check for manipulation of the safety functions.

Only one safety door with three safety switches can be connected to a EUROMAP 73 interface.

If further accesses to a plant are required, additional EUROMAP 73 interfaces are needed from the manufacturer of the plant, or a safety controller is installed in a control cabinet. If a safety controller is used, the safety function of several doors is connected to the injection molding system with a contact extension in the control cabinet (3 NO contacts and 3 NC contacts).

Planning new automations with older injection molding machines with a EUROMAP 73 interface is very challenging for many end customers and integrators. Modern safety switches and additional safety doors are difficult to integrate.

1 End switch + 2 Safety switches  
External safety device closed

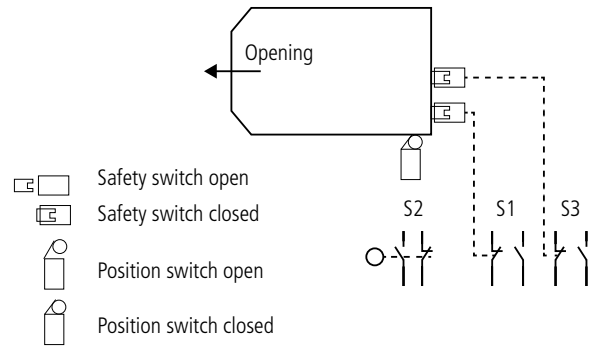

EUROMAP 73 protection with three safety switches on the safety door.

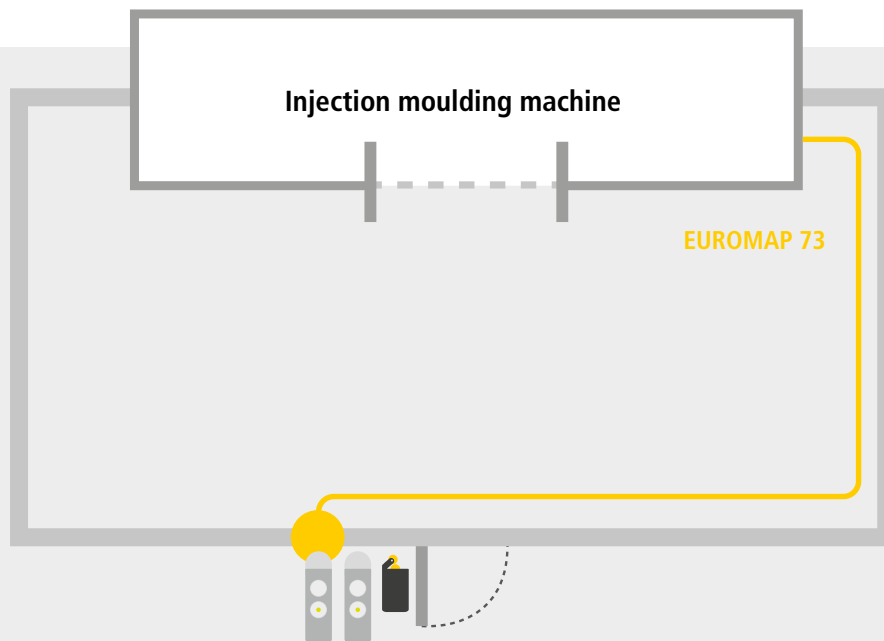

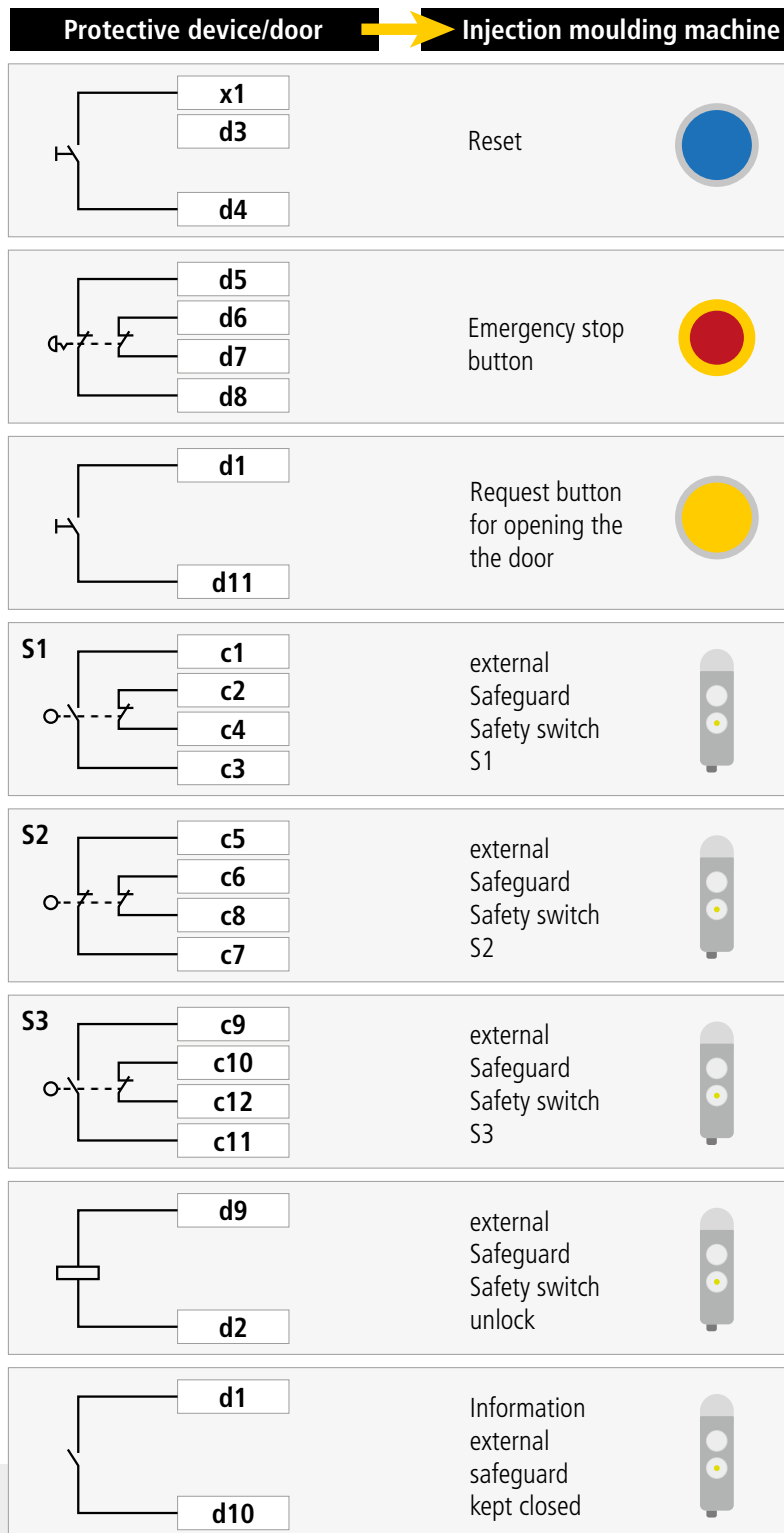

### Problems that arise with a EUROMAP 73 interface:

- ? How can existing safety guard locking in highly coded design and with OSSD signals be connected to a EUROMAP 73 interface without changing the entire safety concept?
- ? How can several safety doors be connected with only one existing EUROMAP 73 interface?
- ? How can the rear step protection be realized for complex and non-visible plant components?



# Example of the Safety Simplifier Implementation of Euromap 73

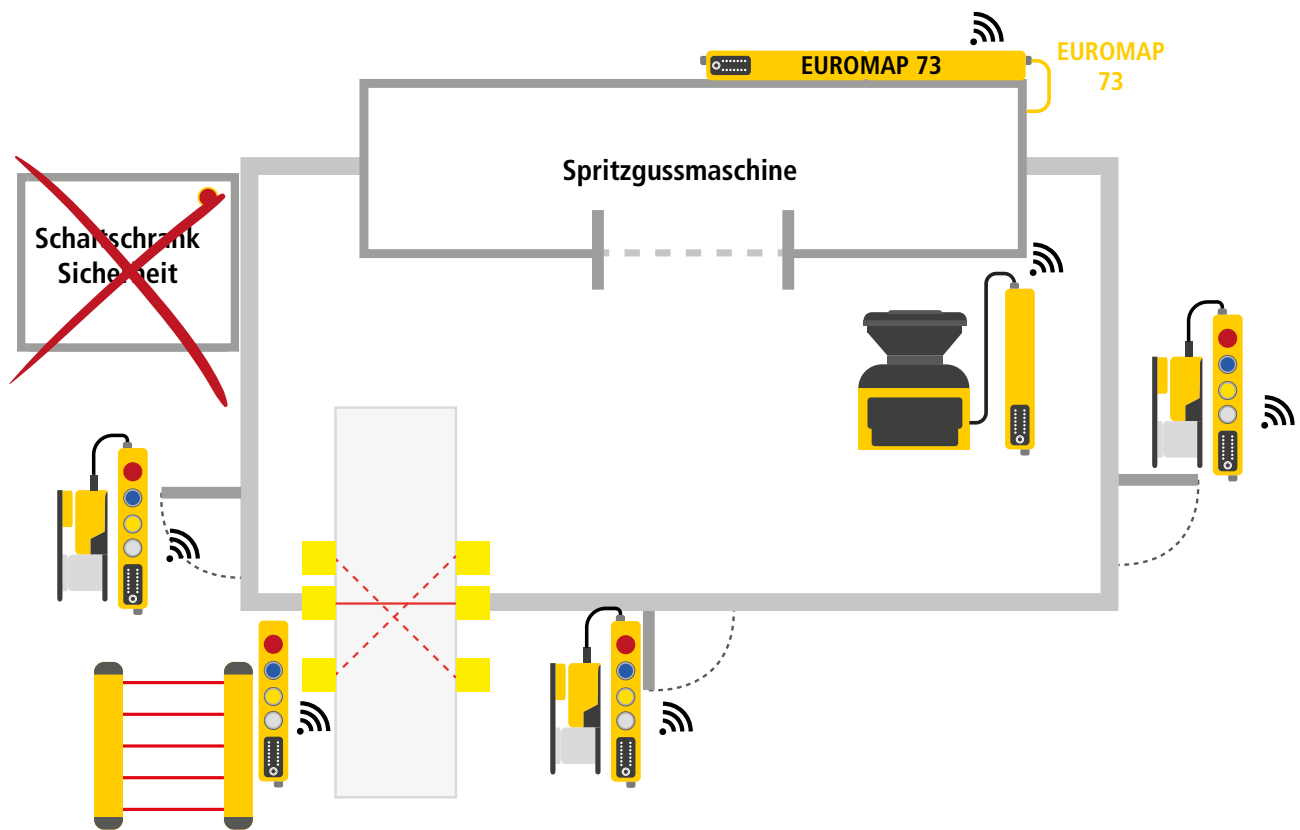

## Advantages

- ✓ Plug & Play: Safety Simplifier units with matching safety door protection for each door and with prepared EPlan macros, makes planning and design easier
- ✓ Flexible safety concept without safety controller in the control cabinet, which must be wired and planned
- ✓ Easily expandable for up to 15 doors
- ✓ In retrofit systems, modern door switches with RFID can replace existing doors with 3 safety switches
- ✓ Easy maintenance and commissioning with the free software Simplifier Manager

# EUROMAP 67

## Use of EUROMAP interfaces on robots and units

The connections on an injection molding machine for units and additional machine modules are precisely defined. The integration of a robot which for example removes workpieces, is defined and described using EUROMAP 67.

### Information of the interface is divided into:

- ✓ non-safe functional conditions of the injection molding equipment
- ✓ non-safe functions of the robot
- ✓ safe functions of the injection molding system and the robot

Connection	ZA5
Tool closed	ZA6
Tool open	ZA7
Tool on intermediate stop	ZA8
+24 V DC from handling	ZA9
SGM in automatic	ZB2
Ejector is at the back	ZB3
Ejector is in front	ZB4
Core puller 1 in pos. 1	ZB5
Core puller 1 in pos. 2	ZB6
Core puller 2 in pos. 1	ZB7
Core puller 2 in pos. 2	ZB8
0 V from handling	ZC9

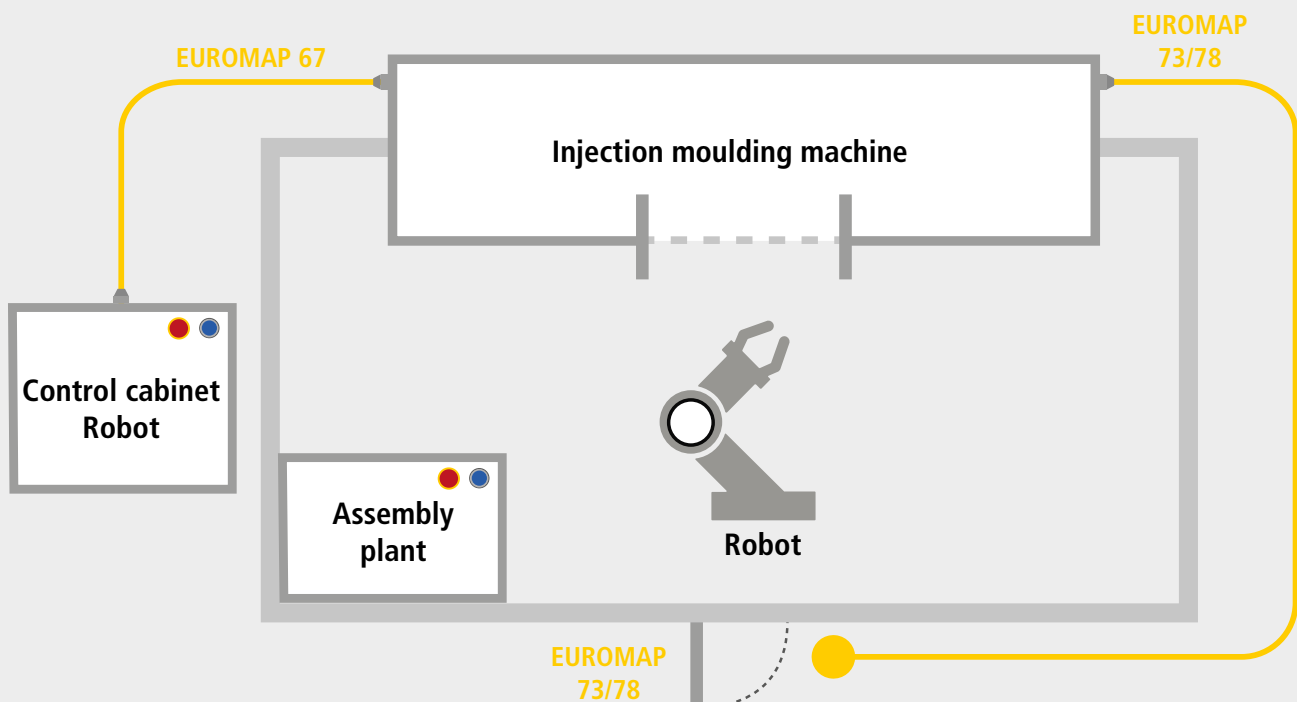



## EUROMAP 67 safety functions between injection molding systems and industrial robots

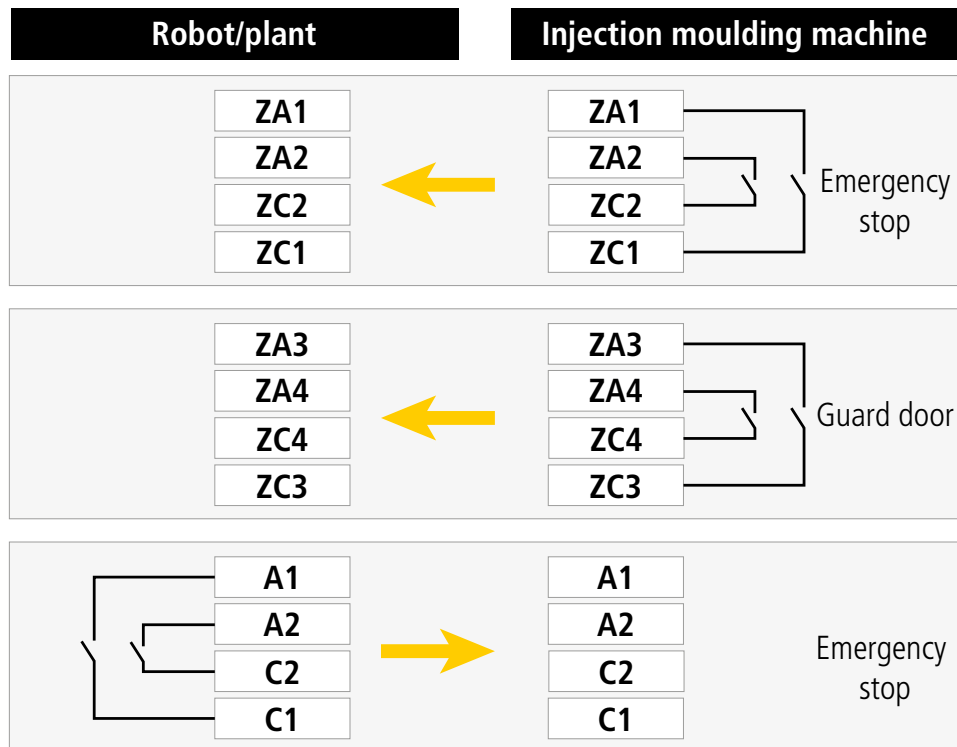

### Problems that occur when integrating a EUROMAP 64 interface:

- ? How can the emergency stop button of the industrial robot switch off other machine parts such as an assembly system in complex applications?
- ? How can the emergency stop button of the assembly system switch off the robot or the injection molding system?
- ? How to prevent the safety circuit from locking each other?

# EUROMAP 67

## with SAFETY SIMPLIFIER



The integration of a EUROMAP 67 interface with the Safety Simplifier facilitates the implementation of complex systems. For the safety concept, it is necessary to implement an emergency stop connection between all plants of the application.

The Safety Simplifier makes it possible to link up to 15 plants or machine parts with only one EUROMAP 67 interface.

A Safety Simplifier is mounted on each system and the emergency stop functions are programmed via the software using drag & drop of the prefabricated functional modules.

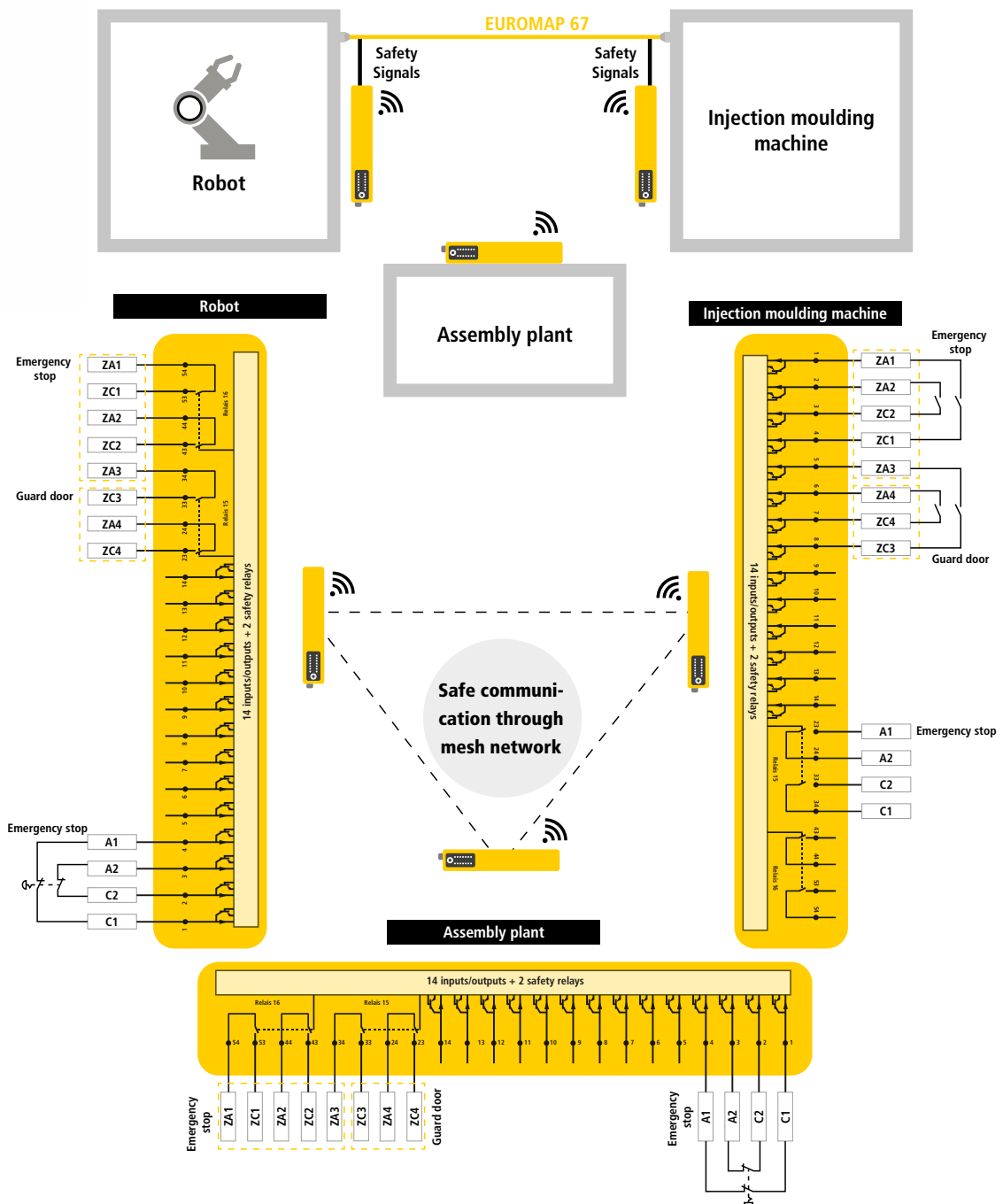

# Example of the Safety Simplifier Implementation of Euromap 67

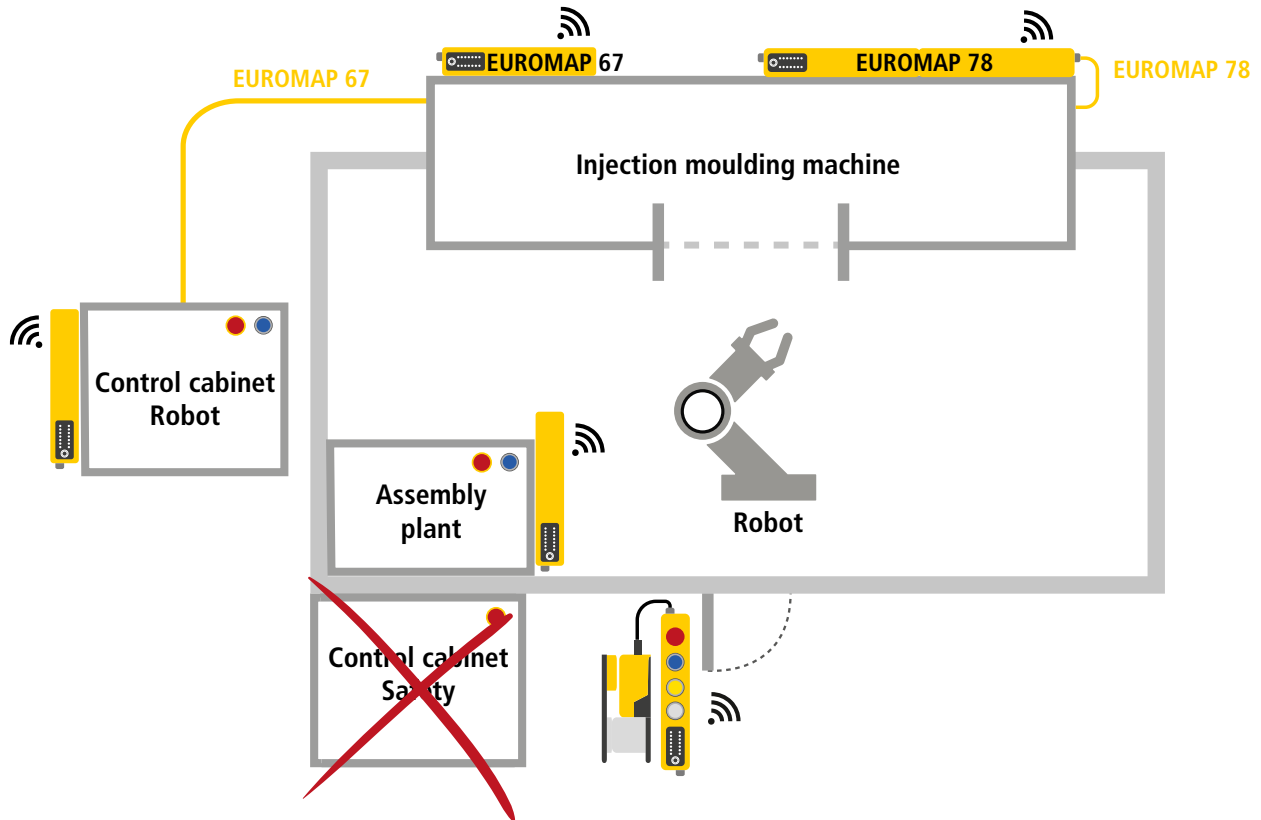

The emergency stop button on the assembly line should switch off both the injection molding system and the robot. At the access door, the emergency stop button must switch off the entire system. In addition, when opening the access door at the safety fence, the injection molding system, the robot and the assembly system must be switched off.

## Advantages

- ✓ No mutual interlocking of the emergency stop circuit. The Safety Simplifier monitors the individual emergency stop circuits independently of the overall system
- ✓ No safety control with contact expansions is necessary in the control cabinet for switching off the individual system parts
- ✓ Thanks to the mesh network, high availability is provided in the system

# SAFETY CHAINING MADE EASY

Wireless Safety, an aluminum safety fence, emergency stop button and a safety door guard provide a consistent safety concept for the automation of an injection molding plant. The plant consists of an injection molding machine, two robots and two conveyor belts for feeding and discharging.

From a safety perspective, the main challenge was the safety interconnection of machines and robots from a wide range of manufacturers. Thanks to the Safety Simplifier's Plug & Play solution, safety is now provided where it is needed. Additional safety cabinets were no longer necessary here, as the system communicates with each other in a secure mesh network. If a plant is interlinked, the emergency stop buttons must also be interlinked due to normative requirements, because in an emergency all machines or robots must stop by actuating a single emergency stop. The relay outputs of all implemented Safety Simplifiers



switch together or individually, depending on the application, to ensure safe stop of the machines. The power supply (10-30 VDC) can also be easily disconnected from the plant power supply. In this way, individual machines can also be switched off in a linked plant without having to cause an emergency stop of all machines. Among other things, this facilitates the installation of emergency stop solutions, since no further evaluation unit is required for the control unit.

The special advantage of this solution: Huge savings in wiring. With the help of wireless safety, many meters of cable material can be saved.





# SAFE CONNECTION OF A COMPLEX INJECTION MOLDING SYSTEM



## Interfaces for EUROMAP 78

The complex system of an injection molding machine for the injection molding of socket plugs included several additional system parts that had to be connected. To ensure the safety of all components and to use the EUROMAP 78 interface to connect to the injection molding machine, the Safety Simplifier was used with a EUROMAP 78 interface. The safety solution connected the plant components and included protection of the machines, robots, plant components and safety doors. An aluminum safety fence made by Safety System Products was used here as a guard.

In addition, safety switches such as tGard and HOLDX R with RFID sensors were installed on the safety doors. Safety functions such as emergency stop, door request or reset are implemented directly in the Safety Simplifier and could be configured without programming knowledge. The safety-related linking enabled a much simpler implementation of the project compared to installing additional EUROMAP interfaces on the plant, which is the usual procedure, or building and wiring a control cabinet with a safety controller for the entire machine safety.



Safety chaining of all safety doors

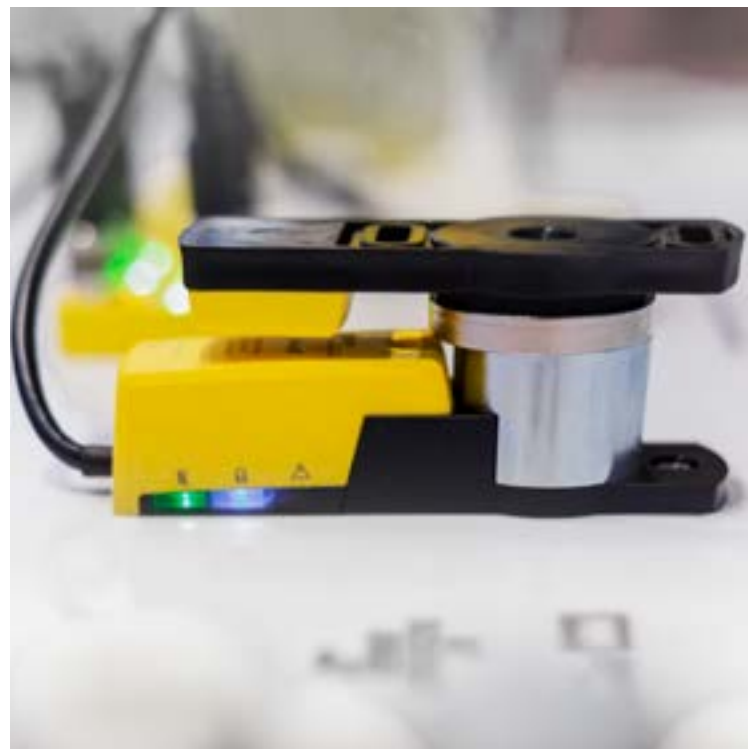



# Safety switches

## PLANT ACCESS PROTECTION

SSP products have proven themselves in practice for many areas of application in access control and monitoring of protective devices on machines, systems and for robot cells.

- **RFID safety sensor**
- **Guard lock**
- **Safety switch**
- **Key transfer system**



# SSP

Safety System Products

**SSP Safety System Products** GmbH & Co. KG

Zeppelinweg 4 · 78549 Spaichingen · Germany

Tel. +49 7424 98049-0 · Fax +49 7424 98049-99

[www.safety-products.de](http://www.safety-products.de) · [info@ssp.de.com](mailto:info@ssp.de)

## INTERNATIONAL PARTNERS

---

**Find them on our website**

[www.safety-products.de](http://www.safety-products.de)



### Our contribution

Environmentally friendly paper  
FSC®, EU Ecolabel



Modifications and errors excepted

June 2023 | 3.0

1003864

**we simplify safety**