

**COGNEX**



# Ultimate Flexibility, Unmatched Code Reading

DataMan 280 Series

## DataMan 280 Series Fixed-mount Barcode Readers

Premium decoding technology  
in a compact form factor

The DataMan 280 is an all purpose, all powerful barcode reader designed to perform in a variety of code-reading environments. The 280 series incorporates AI tuning to ensure high read performance on difficult applications.

From hands-free code reading in a logistics facility to decoding direct part markings (DPMs) in a manufacturing plant, DataMan 280 readers increase traceability, and boost throughput by delivering the highest read rates.



DataMan 280



DataMan 282

### Key features



#### High performance in a compact package

Improve throughput and productivity across a variety of applications using industry-leading 1D/2D algorithms, including HotBars and PowerGrid, and uniform lighting.



#### Robust reading

Operate in the most challenging code-reading environments with dynamic auto-focus and advanced high dynamic range imaging.



#### Out-of-the-box functionality

Unbox, install, and decode with fast, intuitive deployment even for specialized applications.



#### AI-enabled tuning

AI tuning allows for fast setup on challenging applications.

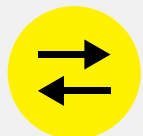

#### Flexible connectivity and communications

Increase efficiency and exchange information faster:

- 1 GB/second Ethernet
- Rapid image offload
- Easy data management
- Multi-reader sync

# Solve tough manufacturing and logistics applications

DataMan 280 series barcode readers provide unprecedented read rates on 1D and 2D label-based codes and DPMs.

## Automotive DPM reading

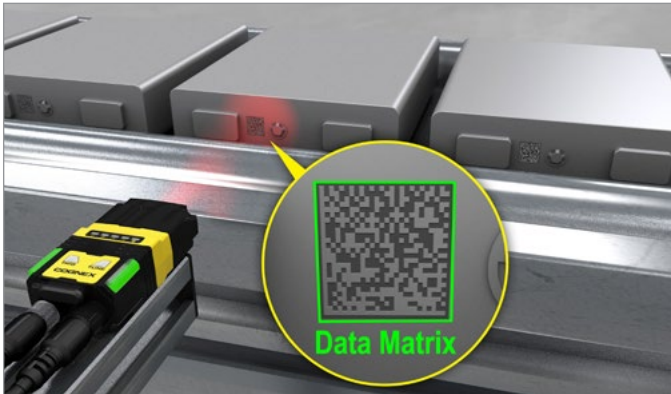

Easily decode difficult DPMs on automotive part surfaces.

## Medical device DPM reading

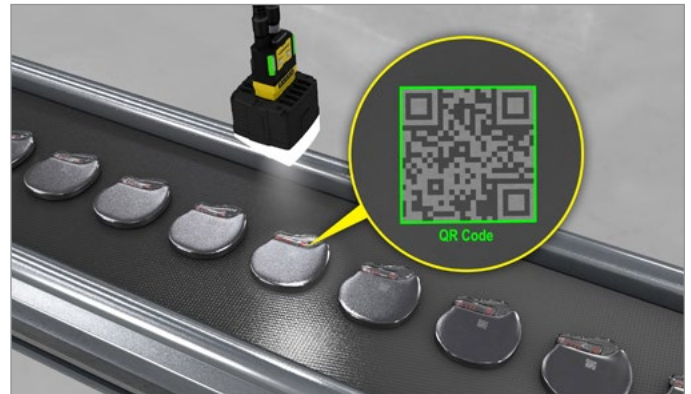

Accurately read and trace small DPMs on critical medical devices.

## High-speed barcode reading

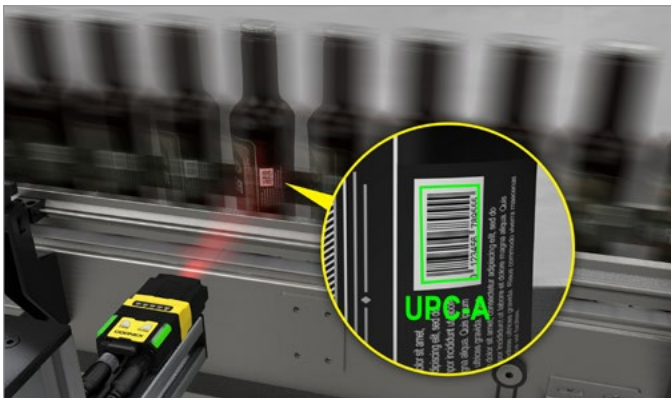

Reliably read every barcode on high-speed manufacturing lines.

## Multiple barcode reading

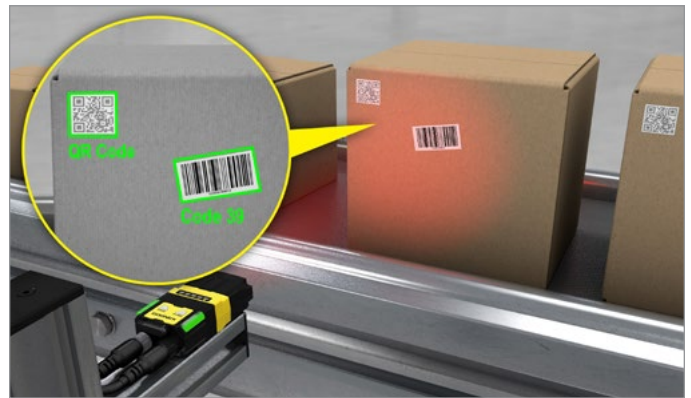

Read multiple codes simultaneously in the field of view and offload images quickly.

## Pallet code reading



Read 1D and 2D label-based codes on pallets, even codes behind specular wraps.

## Hands-free barcode reading



Improve handling efficiency with a large depth of focus that accurately reads user-presented codes.

# Take your operations to the next level with advanced reading and imaging technology

DataMan 280 series barcode readers leverage patented decoding algorithms and imaging technology to deliver unparalleled read rates for 1D and 2D label-based codes, as well as DPMs.



**1DMax™ with Hotbars®** is optimized for omnidirectional 1D barcode reading and decodes low-resolution codes up to 10X the speed of a conventional barcode reader.

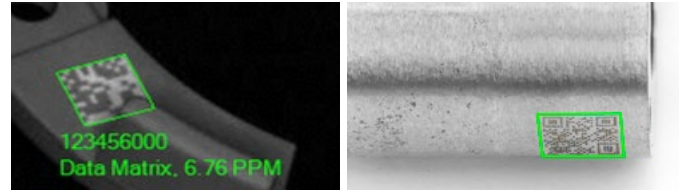

**2DMax® with PowerGrid®** is designed to read 2D codes (including QR codes) with significant damage or complete elimination of finder and clocking pattern, or quiet zone.

Conventional Sensor

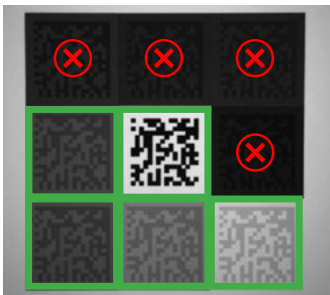

HDR

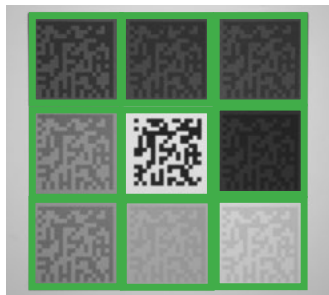

**High Dynamic Range (HDR)** enables you to read codes in low-contrast conditions, using an advanced image sensor to reduce dark noise, improve saturation capacity, and interpret low-light codes.

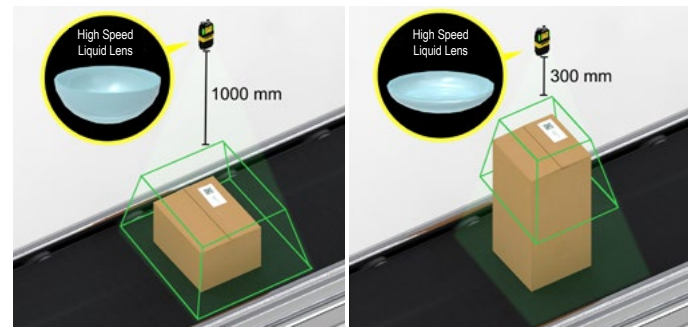

**High-Speed Liquid Lens (HSLL)** technology dynamically autofocuses without any mechanical parts, addressing high-speed, high-variability applications with fewer cameras and in less time.

# Simplify setup and deploy real-time performance monitoring with Edge Intelligence

DataMan 280 series readers combined with Cognex Edge Intelligence (EI) transform big data into smart data to improve overall equipment effectiveness and throughput. EI allows users to configure multiple devices simultaneously, facilitating immediate system performance monitoring and analysis. The technology informs users when issues occur, allowing operators to identify and resolve root causes faster using powerful analytics and image view tools.



Connect via web browser

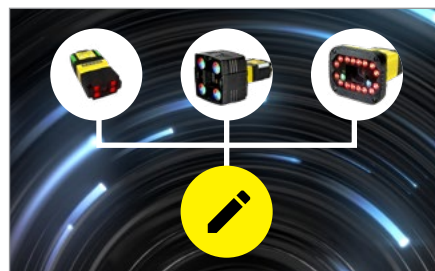

Configure multiple devices simultaneously



Identify performance trends and issues

# Full-featured barcode reader addresses broad range of symbologies and markings

Accelerate throughput, achieve higher read rates, and be prepared for any code-reading challenge. DataMan 280 series barcode readers utilize patented decoding algorithms and imaging technology to deliver the highest read rates for DPMs and label-based codes.

## DataMan 280



1.6MP sensor

Powered by 24V or Power over Ethernet (PoE)

## DataMan 282



2.0MP sensor

Powered by 24V

### High-powered integrated torch (HPIT)

allows you to switch between red, white, blue and green lighting with a click of a button

### Built in high-powered illumination

**Time-of-flight sensor** paired with HSSL augments depth of field and speed of real-time auto-focus

**Multi-core processor** enables fast image processing

**Indicator lights** for operator feedback

**Gigabit Ethernet** delivers fast communication speeds and image offload

**USB-C connection** enables instantaneous, seamless communication (serial or keyboard output) to devices such as computers, touchscreens, or displays

Compact form factor with **in-line** or **right-angle** configuration



## Flexible platform built for scalability

Whether you need a standard solution for straightforward decoding or advanced lighting and optics for specialized applications, the modular design of DataMan 280 series readers allows you to customize your reader to fit your needs. Readers are built to order and ready to address a variety of applications.

### DataMan 280

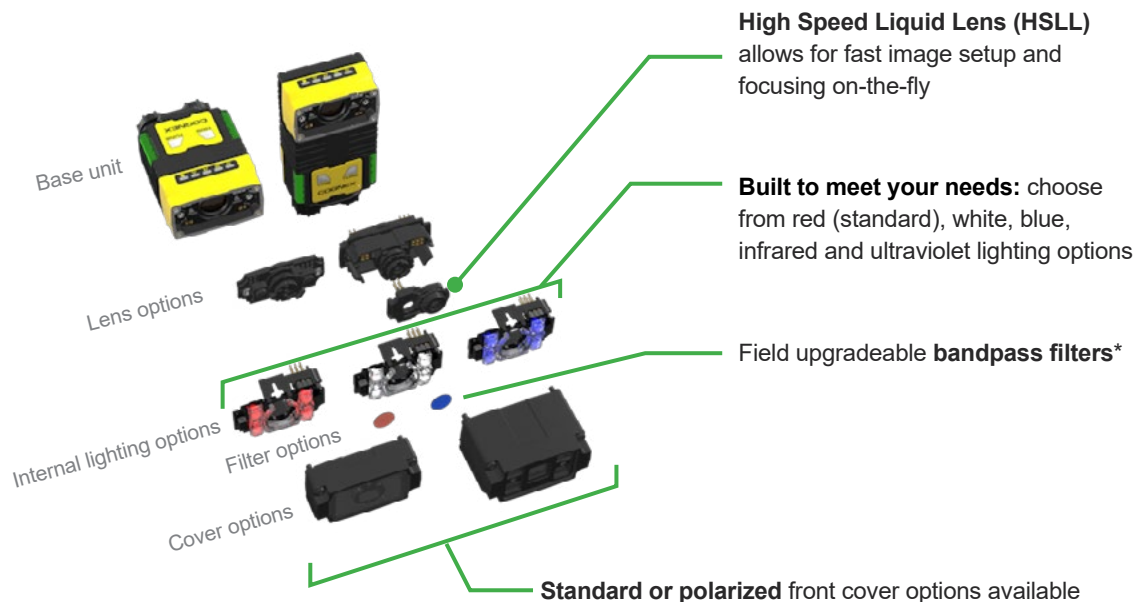

\*Sold separately

## Build YOUR Reader

Select from different combinations of lenses, lighting, and covers to build your custom solution.



[configurator.cognex.com/en/dataman280](https://configurator.cognex.com/en/dataman280)

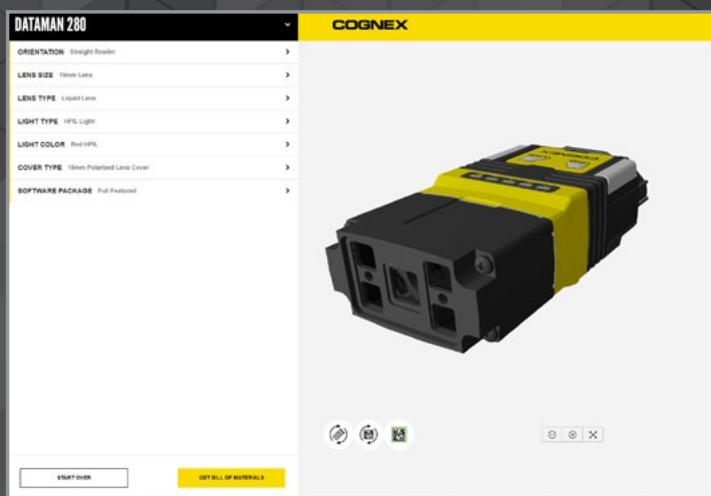

# DataMan 282



## Enhanced code reading with a single click

DataMan 282 readers are equipped with the HPIT, enabling operators to quickly toggle between red, white, blue and green lighting options. The HPIT ensures you have the right lighting for your application, enabling optimal contrast, a greater depth of field, and higher read rates.

Multicolor lighting can also serve as a performance indicator, delivering immediate color-coded operator feedback.



\*Sold separately

## DataMan 280 Series Specifications

	DataMan 280	DataMan 282
Algorithms and Technologies	1DMax, 2DMax, Hotbars, PowerGrid	
Image Sensor	1/3" CMOS	1/2.8" CMOS
Image Sensor Properties	Diagonal 6.21 mm, 3.45 $\mu$ m square pixels	Diagonal 6.17 mm, 2.8 $\mu$ m square pixels
Image Resolution	1440 x 1080 pixels	1920 x 1080 pixels
Electronic Shutter Speed	Min. exposure: 29 $\mu$ s Max. exposure: Up to 10 ms (internal illumination) / Up to 200 ms (external illumination)	
Acquisition	Up to 45 Hz	
Lens Options	6.2 mm or 16 mm High Speed Liquid Lens	8 mm, 12 mm, or 16 mm High Speed Liquid Lens
Trigger and Tune Buttons	Yes, with Quick Setup Intelligent Tuning	
Aimer	2 LEDs	Laser cross pattern (class 2)
Discrete Inputs	2 opto-isolated, 2 configurable	
Discrete Outputs	2 opto-isolated, 2 configurable	
Other I/O Points	2 user configurable as inputs or outputs	
Status Outputs	5 status LEDs, audible beeper, 2 visual indicator lights	5 status LEDs, audible beeper, 2 visual indicator lights, 4 HPIT light color options
Lighting	Standard: 4 LED lights for 6.2mm lens (red, blue, white, IR, and UV options) HPIL: 4 LED high-powered lights for 16 mm lens (red, white options) Optional bandpass filters. Front cover options: polarized/half-polarized and clear.	HPIT: 4 multi-color LED lights (red, green, blue, and white) Optional bandpass filters. Front cover options: clear, diffused, polarized and dome.
Communications	Serial and 1 GB/second Ethernet interface, USB-C, and keyboard capability	
Protocols	RS-232, TCP/IP, PROFINET (class B), EtherNet/IP™, SLMP, CC-Link, Modbus TCP, NTP, SFTP, FTP, MRS, Java Scripting enabled for custom protocols	
Power	24V +/- 10% and Power over Ethernet (PoE)	24V +/- 10%
Power Consumption	$\leq 7.5W$	
Material	Zinc alloy/aluminum	
Weight	6.2 mm: 141 g; 16 mm: 169 g Right angle configuration adds 50 g	290 g Right angle configuration adds 50 g
Operating Temperature	0–40° C (32–104° F)	
Storage Temperature	-10–60° C (14–140° F)	
Operating and Storage Humidity	<95% non-condensing	
Protection	IP67	
RoHS Certified	Yes	
Approvals	EU [CE], US [FCC], TUV, CB, NRTL, IEC 61010, Korea [KCC], India [BIS]	



# Field of view diagrams

**Working distances**  
Units: mm (*in*)

**Minimum**  
50 (1.97)

**Midpoint**  
300 (11.8)

**Maximum**  
500 (19.69)

**DataMan 280 with 6.2 mm lens**

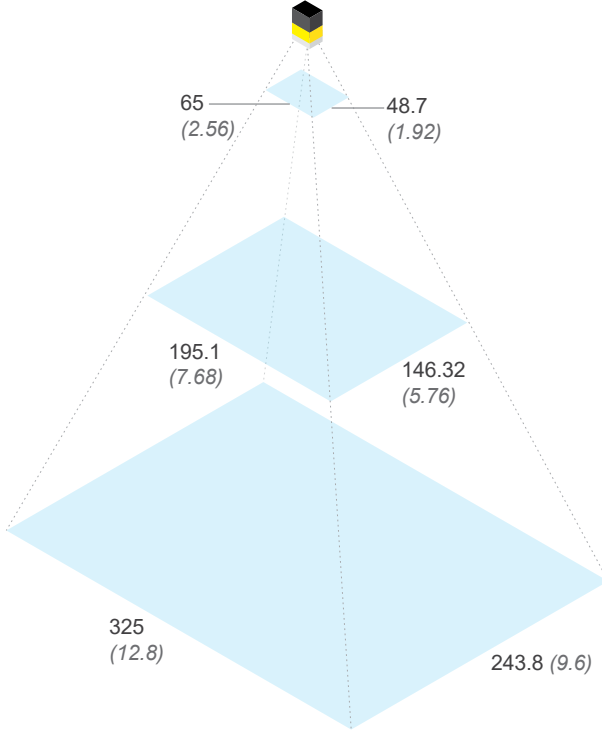

**DataMan 280 with 16 mm lens**

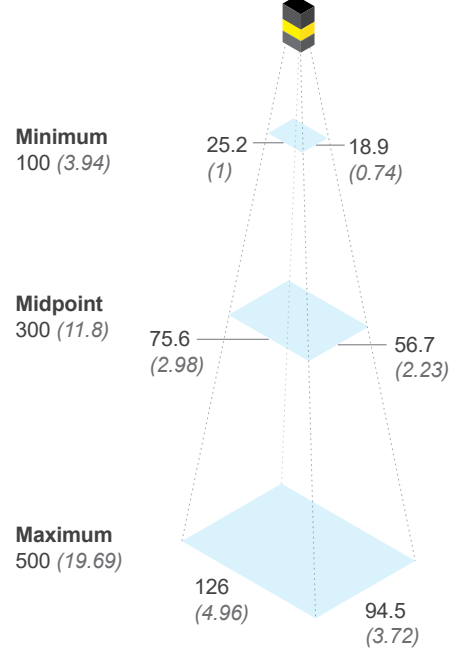

**Working distances**  
Units: mm (*in*)

**Minimum**  
300 (11.81)

**Midpoint**  
750 (29.53)

**Maximum**  
1200 (47.24)

**DataMan 282 with 8 mm lens**

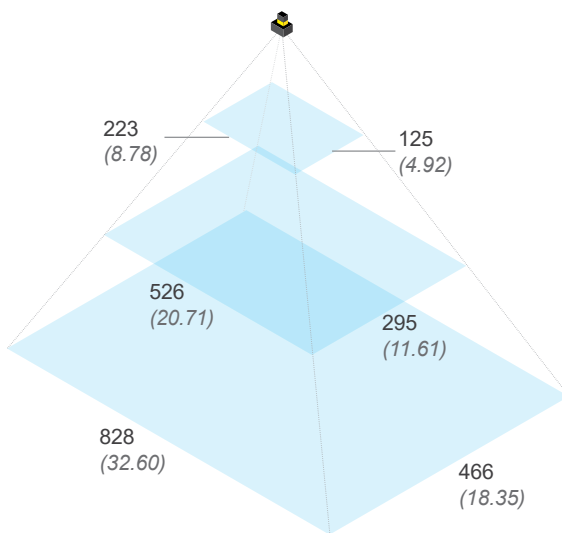

**DataMan 282 with 12 mm lens**

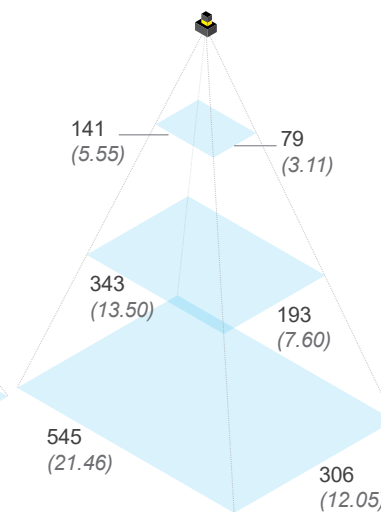

**DataMan 282 with 16 mm lens**

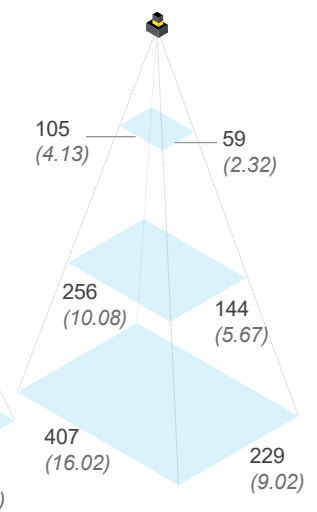

**Focus distances**

**Minimum**  
50 mm (1.97)

**Maximum**  
2000 mm\* (78.74)

\*Applications with working distances beyond 500 mm may result in an in-focus image but light uniformity/intensity will be significantly lower. External lighting is recommended for these scenarios.



## Product configurations and descriptions\*



DataMan 280 series						
	Resolution	Light	Lens	Cover	Orientation	Part Number
	1.6MP	Red HPIL	16 mm HSSL	Half Polarized	Straight	DMR-280X-MAX
					Right Angle	DMR-280X-1541-P
		Red Standard	6.2 mm HSSL	Clear	Straight	DMR-280X-1120
					Right Angle	DMR-280X-1121
	2.0MP	Multi Color HPIT	12 mm HSSL	Clear	Straight	DMR-282X-1960-C
			16 mm HSSL			DMR-282X-1940-C
			8 mm HSSL	Diffuse Dome		DMR-282X-1920-DOM

\*This table includes only the most common product models. To get information on other available models, including angled configurations, please contact Cognex Sales at [cognex.com/contact-sales](http://cognex.com/contact-sales).

## Components and accessories



Power and I/O Cables			
	Product ID	Length	Description
	CCB-PWRIO-05	5M	M12-12 to flying lead, straight
	CCB-PWRIO-10	10M	
	CCB-PWRIO-15	15M	
	CCB-PWRIO-05R	5M	M12-12 to flying lead, right-angled
	CCB-PWRIO-10R	10M	
	CCB-PWRIO-15R	15M	

Mounting Brackets		
	Product ID	Description
	DM100-UBRK-000	Universal mounting bracket
	DM100-PIVOTM-01	Pivot mounting bracket
	280-BKT-ADAPT	Flat surface mounting plate adapter for DM282 configuration



Ethernet Cables			
	Product ID	Length	Description
	CCB-84901-2001-02	2M	X-coded M12-8 to RJ-45, straight
	CCB-84901-2001-05	5M	
	CCB-84901-2001-10	10M	
	CCB-84901-2001-15	15M	
	CCB-84901-2001-30	30M	
	CCB-84901-2002-02	2M	X-coded M12-8 to RJ-45, right-angled
	CCB-84901-2002-05	5M	
	CCB-84901-2002-10	10M	
	CCB-84901-2RBT-02	2M	Robotic X-coded M12-8 to RJ-45, straight
CCB-84901-2RBT-05	5M		
CCB-84901-2RBT-10	10M		
	CCB-M12X8MS-XCAC	0.5M	X-coded to A-coded Ethernet cable adapter

## DataMan 280 accessories

### Bandpass Filters

	Product ID	Description
	DM150-BP470	Blue bandpass filter (6.2 mm lens only)
	DM150-BP635	Red bandpass filter (6.2 mm lens only)

### Front Covers

	Product ID	Description
	DM280-CVR-62	Front cover (6.2 mm lens)—clear
	DM280-LENS-62CVR-P	Front cover (6.2 mm lens)—half polarized
	DM280-LENS-62CVR-F	Front cover (6.2 mm lens)—polarized
	DM260-LENS-16CVR	HPIL front cover (16 mm lens)—clear
	DM260-LENS-16CVR-P	HPIL front cover (16 mm lens)—half polarized
	DM260-LENS-16CVR-F	HPIL front cover (16 mm lens)—fully polarized

## Dimensions Units: mm, [in]

### DataMan 280 with 6.2 mm lens front cover

#### Straight configuration

[Download CAD files](#)

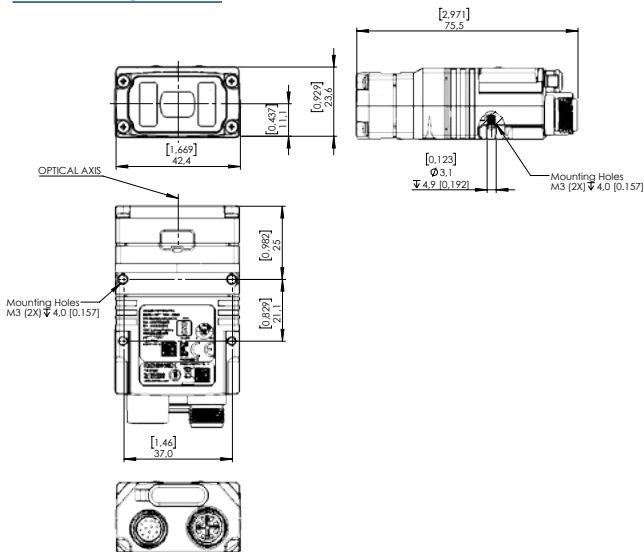



#### Right angle configuration

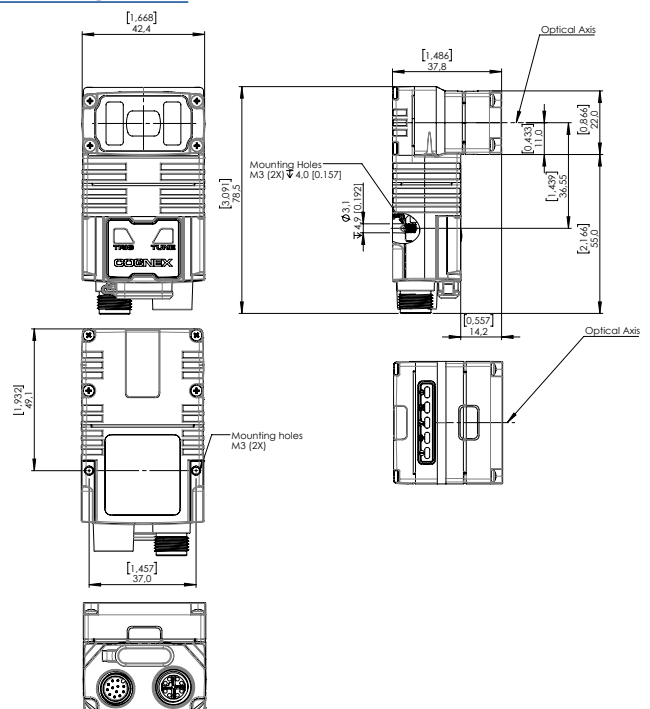

[Download CAD files](#)



### Bandpass Filters

	Product ID	Description
	280-TORCH-BP450	Blue bandpass filter (450 nm)
	280-TORCH-BP635	Red bandpass filter (635 nm)

### Front Covers

	Product ID	Description
	280-HPIT-COVPOL	HPIT cross polarized cover
	280-HPIT-COVCLR	HPIT clear cover
	280-HPIT-COVDIF	HPIT diffused cover
	280-TORCH-DOME	HPIT dome attachment

# DataMan 280 with 16 mm lens HPIL front cover

## Straight configuration

[Download CAD files](#)

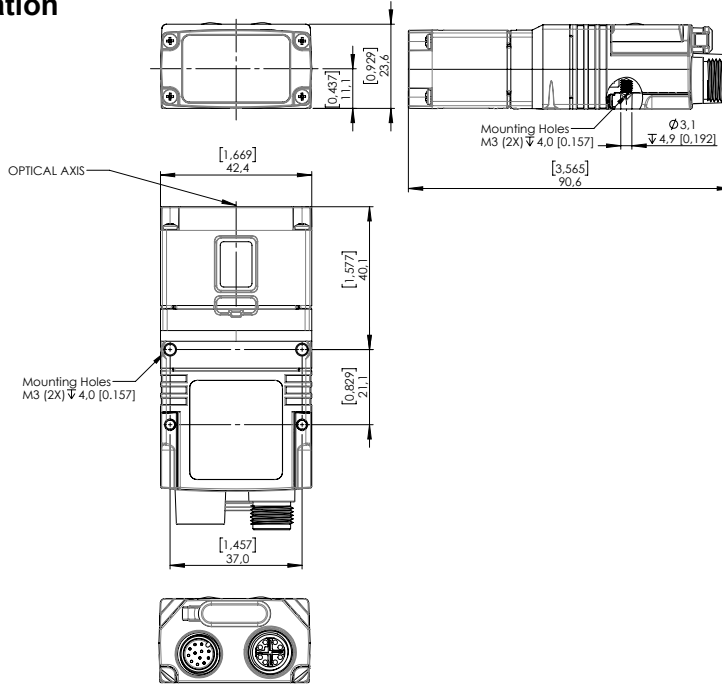

## Right angle configuration

[Download CAD files](#)

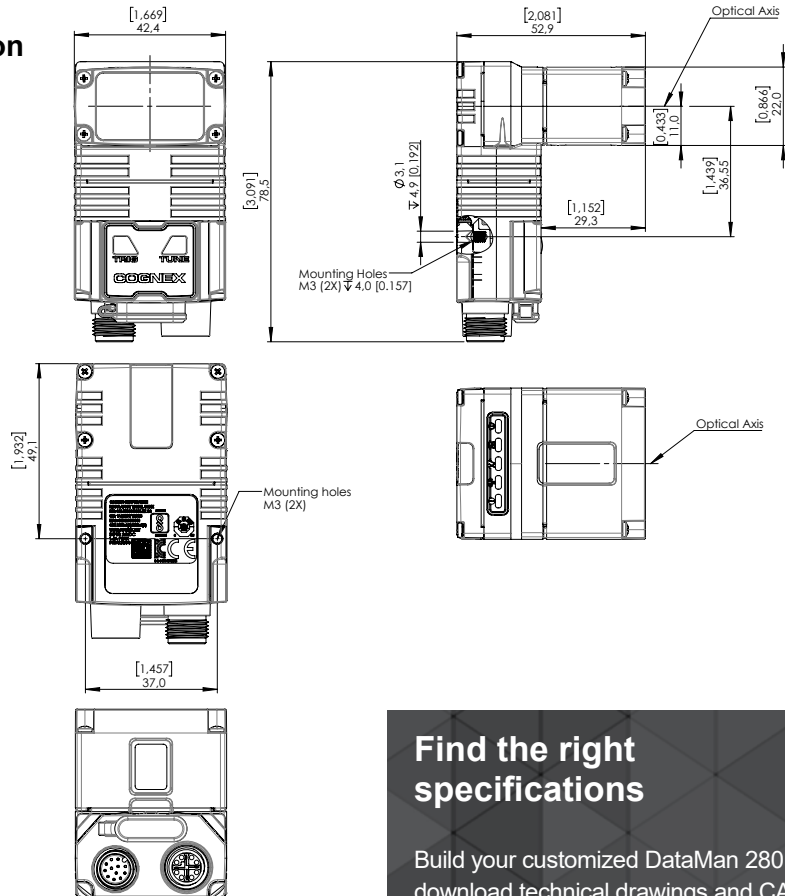

**Find the right specifications**

Build your customized DataMan 280 and download technical drawings and CAD files for your configuration.

[configurator.cognex.com/en/dataman280](http://configurator.cognex.com/en/dataman280)



# DataMan 282

## Straight configuration

[Download CAD files](#)

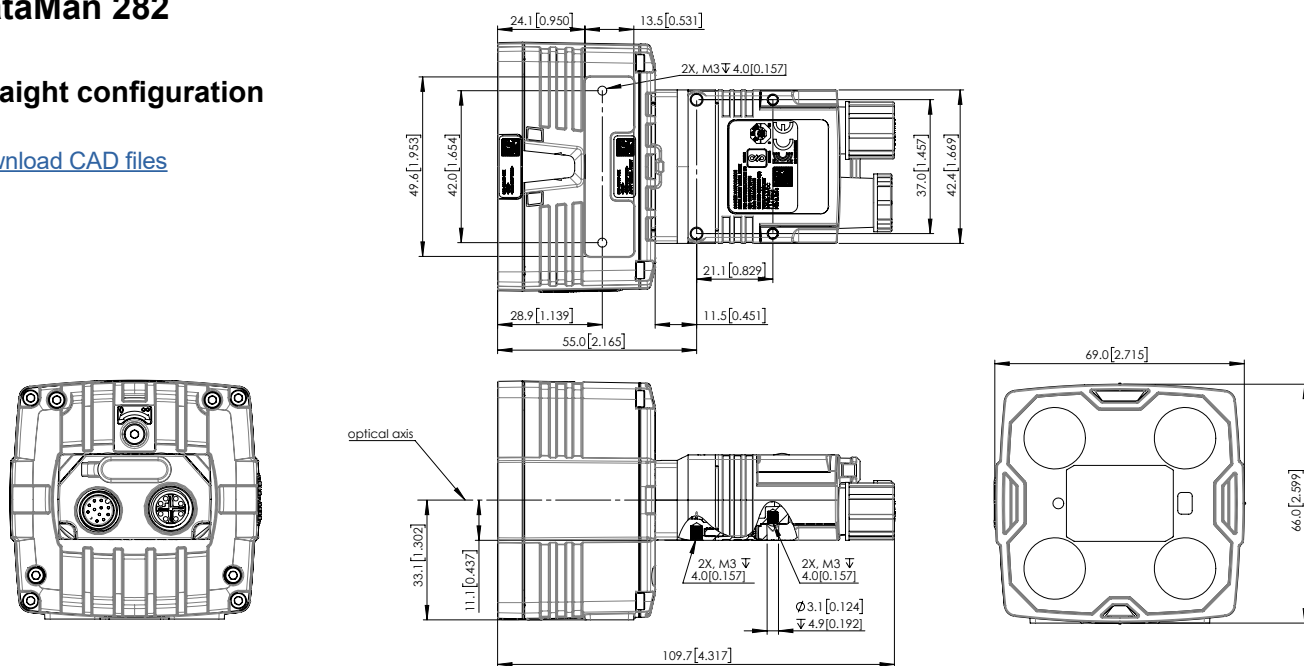

## Right angle configuration

[Download CAD files](#)

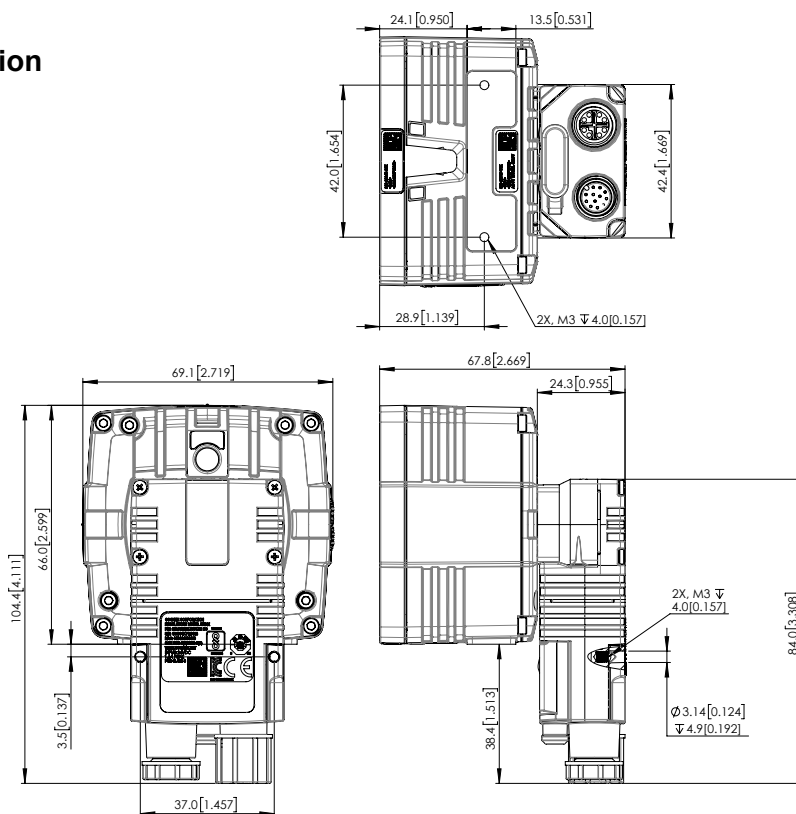

# DataMan 282 with dome diffuser

## Straight configuration

[Download CAD files](#)

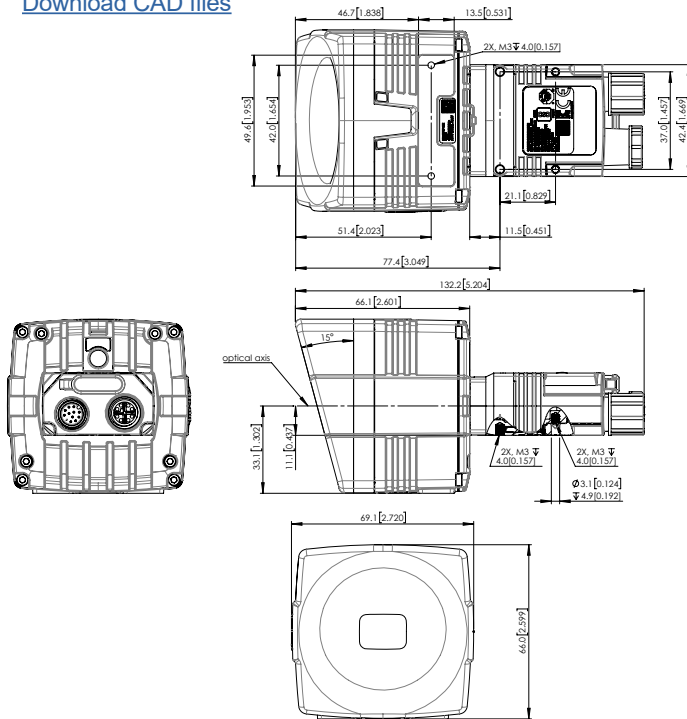

## Right angle configuration

[Download CAD files](#)

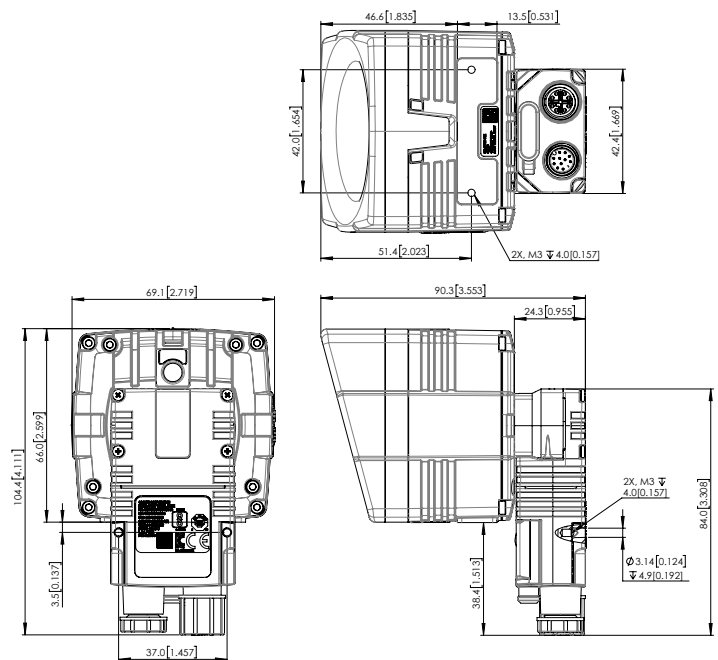

For more information, including software downloads, application examples, and product collateral, please visit:

[cognex.com/dataman-280](http://cognex.com/dataman-280)

# COGNEX

Companies around the world rely on Cognex vision and barcode reading solutions to optimize quality, drive down costs, and control traceability.

Corporate Headquarters One Vision Drive Natick, MA 01760 USA

### Regional Sales Offices

#### Americas

North America +1 844 999 2469  
Brazil +55 11 4210 3919  
Mexico +800 733 4116

#### Europe

Austria +43 800 28 16 32  
Belgium +32 289 370 75  
Czechia +420 800 023 519  
France +33 1 76 54 93 18  
Germany +49 721 958 8052  
Hungary +36 800 80291

Ireland +353 21 421 7500  
Italy +39 02 3057 8196  
Netherlands +31 207 941 398  
Poland +48 717 121 086  
Romania +40 741 041 272  
Spain +34 93 299 28 14  
Sweden +46 21 14 55 88  
Switzerland +41 445 788 877  
Turkey +90 216 900 1696  
United Kingdom +44 121 29 65 163

#### Asia-Pacific

Australia +61 2 7202 6910  
China +86 21 5875 1133

India +91 7305 040397  
Indonesia +62 21 3076 1792  
Japan +81 3 5977 5400  
Korea +82 2 539 9047  
Malaysia +6019 916 5532  
New Zealand +64 9 802 0555  
Philippines +63 2 8539 3990  
Singapore +65 3158 3322  
Taiwan +886 02 7703 2848  
Thailand +66 6 3230 9998  
Vietnam +84 98 2405167

© Copyright 2024, Cognex Corporation. All information in this document is subject to change without notice. All Rights Reserved. Cognex and DataMan are registered trademarks of Cognex Corporation. All other trademarks are property of their respective owners. Lit. No. DM280DS-04-2024

[www.cognex.com](http://www.cognex.com)